



Installation Guide

January 2018

Introduction

The following LUX Architectural Panel Guide has been prepared and intended for persons with experience in the field of siding and soffit installation who have a fundamental knowledge of basic building practices.

Warranty may be voided if proper application and installation practices are not followed.

LUX is designed to be efficient and relatively simple to install, but precision and attention to detail is required for a successful install and it is highly recommended that an experienced professional install the product.

The information provided in this document is offered in good faith and believed to be reliable, but is made without warranty, express or implied, as to merchantability or fitness for a particular purpose. Readers should review this document in conjunction with their design professional's advice, construction drawings, manufacturer's technical literature, building code, and fire code. LUX Architectural Panel does not assume any responsibility for reader's compliance with applicable laws and regulations.

LUX Architectural Panel Features & Properties

LUX Architectural Panel is a 24 gauge ASTM A792 55% Al-Zn Alloy Coated Steel that is pre-painted in a PVDF high endurance paint. LUX Panel has A ratings in fires tests, can withstand extreme weather changes and winds, is impervious to insects, requires virtually no maintenance and is warranted for 25 year paint finish. Unlike wood, it will never rot or support mold or mildew and is easy to clean and maintain.

The LUX Architectural Panels

LUX Panel is available in a 4" (101.6mm) and 6" (152.4mm) V-grooves siding panels as well as 4" (101.6mm) and 6" (152.4mm) V-groove smooth and vented soffit. Panels are cut to custom lengths from 4' to 24' or (1.22 Meters to 7.32 Meters).

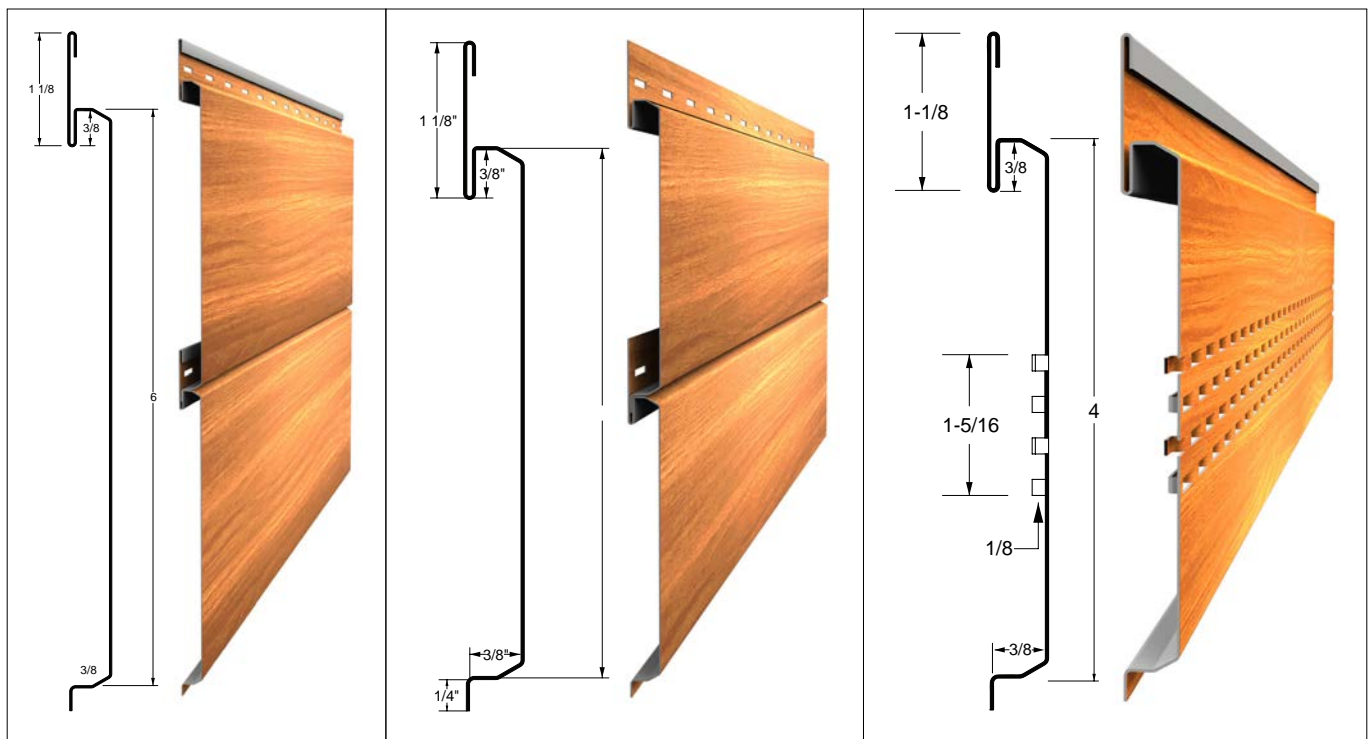

A. 4" Smooth V-Groove

B. 6" Smooth V-Groove

C. 4" Vented V-Groove

Safety Considerations

Always wear and use appropriate Personal Protective Equipment (PPE), taking all precautions to protect eyes during installation and cutting. Gloves are recommended as there are sharp corners and edges on the v-groove panels. When cutting or being exposed to airborne particles always wear an appropriate dust mask. Refer to the OHS Code for further requirements and safety measures for jobsite siding installations.

Transportation

LUX Architectural Panel securely packages and crates each order. In order to maintain integrity of the product precautions must be used when loading and unloading the product. The product should be moved by forklift from the center of the crate taking extra care not to hit the crate with the forks or allow the crate to twist. All shipments are photo-documented on the truck when they leave, and must be in 100% manufacturer condition. When the products arrive immediately check for any crate or product damage. Do not install damaged products.

Storage Considerations

Pre-painted building panels have been successfully used for many years. In general, properly installed building panels under normal service conditions have excellent corrosion resistance. However, pre-painted building panels are subject to premature corrosion failures prior to installation if they are not handled and stored properly on the job site. Excessive storage periods or poor storage conditions often result in water intrusion into panel bundles. Prolonged exposure of bundled panels to wet conditions can cause paint blistering and substrate corrosion. Wet Stack Corrosion in the right conditions can manifest itself in as little as 2 weeks, but typically after 4 weeks early stages of adhesion failure can be detected on panels.



Close-up image of severe "Wet Stack Corrosion." Note smooth, normal surface in upper right corner.



Note when scratched, the primer has been compromised as well as the presence of Zinc Oxide (white rust).

Storage Considerations

Environmental & Service Conditions

Water is a necessary prerequisite for corrosion of stored pre-painted panels. When water or water vapor is available along the sides of a panel bundle, it may penetrate between the panels by capillary action. If proper precautions are not taken during transport, water may be present between the panels upon delivery at the job site. Ambient humidity and temperature cycles will also promote water intrusion into stored panel bundles through condensation. Finally, rain and snow are other potential sources of water that can cause storage corrosion of pre-painted panels.

Besides water, two other important factors that contribute to the corrosion of stored pre-painted panels are temperature and exposure time. Corrosion will accelerate with increased temperature. Given enough time, panel bundles will eventually become wet and storage corrosion may occur under most job site panels. Storage corrosion can be prevented by:

- Reducing site storage time.
- Decreasing water contact.
- Moderating temperature extremes.

Special case factors not considered here are the presence of aggressive soluble chemicals, such as sulfur and chlorine compounds, that might be present in polluted atmospheres, road salt contaminants, or marine environments. It is reasonable to assume that these soluble species would accelerate storage corrosion.

Job Site Storage

Prolonged storage will always increase the likelihood of storage corrosion. Therefore, the best prevention is to minimize the storage time. Proper storage limits the collection of water from rain, snow and condensation on the panel surfaces. Under roof storage is always preferred. If panel bundles have to be stored outdoors, a number of precautions must be taken to prevent storage corrosion. The panel bundles should be stored in a level area out of the way of other construction activities to minimize the number of bundle movements required at the job site. If the bundles are stored on the ground, a plastic ground cover must be put down under the bundle to minimize condensation of water from the ground onto the panels. The bundles must then be raised off the plastic ground cover to avoid contact with water puddles, and allow for air circulation around the bundle to promote drying of condensed water.

Wet, uncured or pretreated lumber should not come in contact with the panel bundles. The panels must be stored on an angle to promote drainage of water off the bundle. Sufficient support must be provided to the raised and angled bundles to avoid excessive bowing, which may result in low spots that could hold water.

The bundle must be completely sheltered with a loose fitting waterproof tarp to protect the bundle during rain or snow events, but allow for air circulation and drying of condensed water. A loose fitting tarp also shadows the bundle from direct sun light and should act to moderate high temperature extremes.

Storage Considerations



Insufficient support in the center of long panels allow "Bowling" or "Sagging" that traps water in the center of the panel length.

It is important NOT to snugly cover panels with a tarp when on the ground. By covering pre-painted panels in this manner, air flow is prevented and moisture in the ground under the tarp is trapped under the tarp and impregnates the bundle of panels. The effect is worse than just letting the bundles of pre-painted panels sit uncovered in the rain. This is because a "humidity chamber" has been created, and sunlight will heat the tarp and accelerate corrosion by means of increased humidity pulled from the ground below.



After just 3 months covered in the manner above, the panel bundle is opened to reveal that moisture has made its way into the layers of sheets.

Proper storage of bundled pre-painted panels is important and to some to be considered "time consuming and costly" to do. However, failure of your panels is an even more costly idea when you have to reorder and wait for delivery. Other costs associated with delays in jobsite completion as well as material replacement are things to consider when debating the use of proper storage methods.

Storage Considerations

NCCA Storage Methods

The National Coil Coaters Association (NCCA) has developed a time tested storage method for pre-painted, bundled panels. This section will lay out the steps for proper storage that will assure your panels remain dry and defect free when it comes time to install them on your structure.

STEP 1



Your pre-painted bundle should be placed on a tarp to prevent ground moisture from being a factor. The bundle should then be placed on top in a sloping position. This allows any moisture that may already be present to gravitate out.

STEP 2



Place scraps of dimensional lumber on the bundles "Cover Sheet". This is to keep the top tarp from resting directly on the panels to increase air flow which will allow moisture to escape.



If you roll the edges of the bottom tarp up as seen above, cutting a hole in the lowest area of the bottom tarp will allow water to escape.

Storage Considerations

STEP 3



Roll your top tarp over the stack allowing enough tarp to stretch out at least 12 inches from any edge of the panel stack.

STEP 4

While using stakes and elastic straps, pull the top tarp tight enough to keep the edge off the ground, creating air flow under the bundle.



When completed, this method will increase storage life of your panels.

Unused portions of open bundles must be recovered. The condition of the tarps and paper wrapping of stored bundles should be inspected daily for damage, puddles and snow accumulation. Damage to packaging or tarps must be repaired and snow accumulation or puddles should be removed. If water is present in the panel bundles, the panels must be separated and wiped dry with a clean soft cloth and stacked with a space between each panel, so that air circulation can complete the drying process.

There is currently no test method to determine the storage corrosion resistance of pre-painted sheet products that has been correlated with actual storage performance; although, there are a number of test methods that have been utilized by the building products industry.

Any technical information or advice in this bulletin is provided without charge as a service to the industry. The use of this information or advice may produce unexpected results, and any persons intending to make use of this information are urged to carry out tests of their own to satisfy themselves they are using the correct materials, approach, and techniques. Correctly following the information and advice should produce a satisfactory result, but LUX Architectural Panel assumes no responsibility whatsoever in relation to such information or advice. Please ensure you have the most current Installation Manual.

Additional Tools Needed

Recommended Equipment

- LUX Sheer
- Metal Snips
- Chalk Line
- Power Drill
- Metal Nibblers
- Rubber Mallet
- Levels
- Tape Measure
- Skill Saw, mitre saw or radial arm saw with ferrous blade

Warning

Do not nail LUX Panel and follow installation instructions for proper screw choice and desired tightness of screw.

Preparation

LUX Panel is ready to install upon delivery.

If you have ordered your product according to a cut sheet, make sure to review the length of each panel in accordance with the cut sheet before attaching to substrate.

It is advised the the protective film be removed from the ends of the panels before they are inserted in to finishing trims.

As the system is designed to be installed from the bottom up, it is imperative that you drill 1/8 weep holes every 19" (483mm) on your starting panel before it is inserted into the starter strip and adhered to substrate. Failure to do so will likely mean that your installation will likely not adhere to building code and will also void your warranty.

Temperature Considerations

While the expansion and contraction coefficient of LUX Panel is extremely low you must follow installation instructions regarding spacing against trims and by allowing the panel some room to float by not overtightening screws.

Code Compliance

The applicable Building Code and Fire Code are determined based on the project site location as there can be various code changes per province, city and region. LUX Architectural Panel cannot address all the various codes in this guide. Project Designers, Builders, Architects and Engineers must understand the applicable code and install exterior cladding products within the guidelines of these codes. The requirements of the Local Building Codes must be observed as a minimum requirement of the installation of LUX Panel.

Cutting LUX Boards

LUX is best cut along the profile and ideally with the custom designed LUX Sheer. It can also be easily and cleanly cut with a quality ferrous blade. A skill saw, mitre saw or radial arm saw can all be used to create clean cuts of the panel and trims. Nibblers or snips can also be used to clean up cuts or to cut lengthwise down the center of a panel. Always wear proper protective equipment when cutting LUX and ensure the panel and saw are on a level plane.

Care & Maintenance

While factory-applied finishes for metal building panels are so durable that they will last many years longer than ordinary paints, it is desirable to clean them thoroughly on a routine basis, especially when the finish is not washed by rain. Cleaning will generally restore the appearance of these buildings and render repainting unnecessary. An occasional light cleaning will also help maintain an aesthetically pleasing appearance.

Examples of applications requiring maintenance cleaning and inspection include roof cladding, soffits, wall cladding under eaves, garage doors and the underside of eave gutters.

Washing should be done at least every six months and more frequently in coastal areas where marine salt spray is prevalent and in areas where high levels of industrial fallout occur. Mild solutions of detergents or household ammonia will aid in the removal of most dirt, and the following are recommended levels:

1. One cup of detergent (example - Tide[®]) which contains less than 0.5% phosphate, dissolved into five gallons of warm water. (NOTE: The use of detergents containing greater than 0.5% phosphate is not recommended for use in general cleaning of building panels. NEVER BLEND CLEANSERS AND BLEACH.)
2. One cup of household ammonia dissolved into five gallons of water (at room temperature).

Using either solution and working from the top to the bottom of panels, use a well-soaked cloth, sponge, brush (with very soft bristles) or low-pressure spray washer to clean the surface. Application should be gentle to prevent shiny spots. We do not recommend the use of scouring powders or industrial solvents, since these agents may damage the paint film. Solvent-containing cleaners, such as Fantastic[®], are very effective and can be used without concern. If mildew or other fungal growth is a problem and cannot be removed as outlined above, household bleach mixed at a concentration of one gallon of bleach to five gallons of water together with one cup of a mild soap (e.g. Ivory[®]) to aid wetting is recommended. The surface should be thoroughly rinsed with clean water after cleaning to remove traces of detergent.

All exposed metal areas, such as scratches, are susceptible to rust and should be spot-painted with touch-up paint. Also, accumulated debris such as metal particles, leaves, branches, trash, dirt, pollution fallout, etc., should be removed. This removal and the regular cleaning of surfaces by hosing will help prevent the settling of localized areas where accelerated corrosion might occur. Accumulations of wind-borne salty deposits in seaside locations can have a particularly aggressive effect on metal products. These salty deposits are readily removed by a gentle hosing with clean water.

Any technical information or advice in this bulletin is provided without charge as a service to the industry. The use of this information or advice may produce unexpected results, and any persons intending to make use of this information are urged to carry out tests of their own to satisfy themselves they are using the correct materials, approach, and techniques. Correctly following the information and advice should produce a satisfactory result, but LUX Architectural Panel assumes no responsibility whatsoever in relation to such information or advice. Please ensure you have the most current Installation Manual.

LUX Panel V Groove Installation

LUX panel steel cladding is designed to be installed vertically, horizontally, diagonally and under overhangs as a soffit installation to interior or exterior surfaces. LUX panel is a premium metal cladding product with a high level of finish and engineering detail so it is recommended that LUX be installed by an experienced professional who can reflect these qualities. Importantly, the overall quality of the final LUX installation is dependent on the installer's experience, skill and attention to detail, so in order to ensure a beautiful and long-lasting finished product, professional installation is highly recommended.

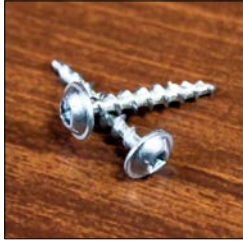

Fig.01

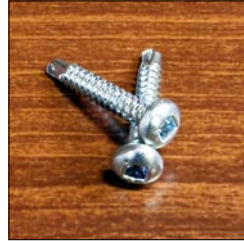

Fig.02

LUX panel should be installed using a modified #8 truss head screw (Fig. 01) for attaching the panel into wood and #8 self-tapping pan-head screw (Fig. 02) for attaching panels to steel studs. Screws are sold by the pound (Approximately 200 pieces per lb.) and by the box (8000 pieces).

LUX panel is manufactured from cold rolled pre-finished steel which gives it superior strength and durability.



Fig.03



Fig.04



Fig.05



Fig.06



Fig.07



Fig. 08

LUX panel can be cut using the LUX Stand-alone shear (Fig. 04), snips (Fig.05), nibblers (Fig.06) and power saws (Fig.07). A metal cutting blade such as Freud Diablo Steel Demon 48 tooth TCG Ferrous Metal Cutting Blade (Fig.08) is recommended.

***NEVER use a grinder to cut. It will damage material and void the warranty.**

If using a sliding compound miter saw the panel will cut better if the saw is pulled across the panel toward the operator and not down onto the panel.

V Groove Panel Installation



Fig.09

When attaching LUX panels, it is important to place the screws centered in designated screw hole (Fig. 09). The screw pattern for soffit that runs parallel with the building should be fastened at maximum 24" and siding applications (Vertical or horizontal) should have a maximum spacing of 24" on center.

At end of a panel, place the screw tight to one end of the screw flange in order to lock the panel in place and keep it from moving from that spot allowing expansion from that point (Fig. 10).



Fig.10



Fig.11

The panel should be hung on the wall using recommended screws and should not be nailed. Hanging the panel this way will allow for expansion and contraction of the panel, as well as allow the panel to float over minor waves and imperfections in the wall. Do not overtighten fastener as panel should be able to float on the wall (Fig. 11). Fig.11 demonstrates 1/16" - 1/8" gap between wall and panel.

When installing LUX Panel in an underside application, such as a typical soffit overhang it is okay to screw into the flange at any point as expansion and contraction is less of a concern (Fig. 12).



Fig.12

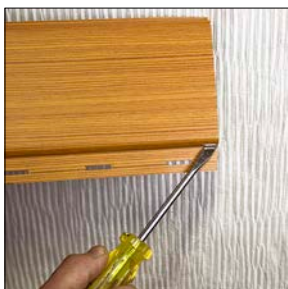

Fig.13

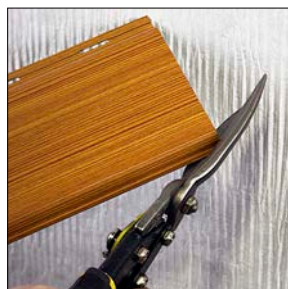

Fig.14

During the manufacturing process the ends of the panels can be slightly compressed (Fig. 13). Either cut the tongue of the next panel to be fitted at an angle or place a flat screwdriver in the compressed end and twist open (Fig. 14).

Soffit Installation

Install panels either at a right angle away from the wall (Fig. 15), or parallel with the wall attaching the panels to blocking at minimum of 24" (Fig. 16). Trims are installed similarly in both applications as viewable in (Fig. 15) + (Fig.16).



Fig.15



Fig.16

When installing LUX panel in a soffit application, the panels can be "butted" together length wise (Fig. 17). Ensure that you use only the factory cut ends and that the joints are staggered at least 16" apart. Butt jointing is only recommended for soffit installation and must have substrate under the joint (Fig. 18). If trimming is required, apply one of the methods outlined in the **Trimming Panel** section of the manual.

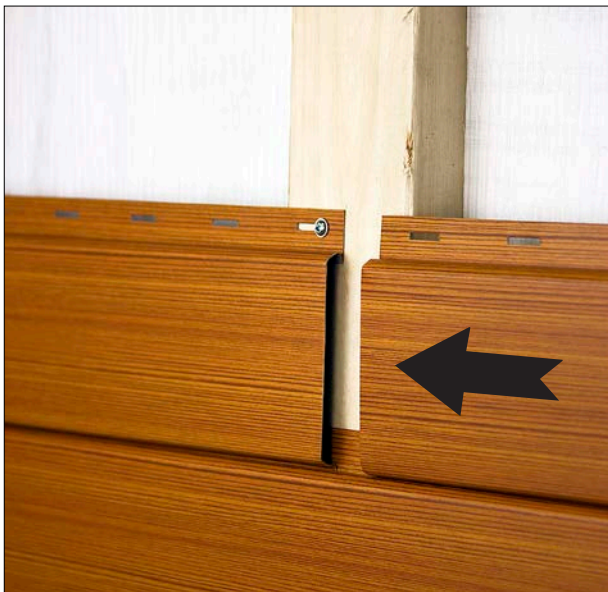

Fig.17



Fig.18

Wall Installation - Horizontal

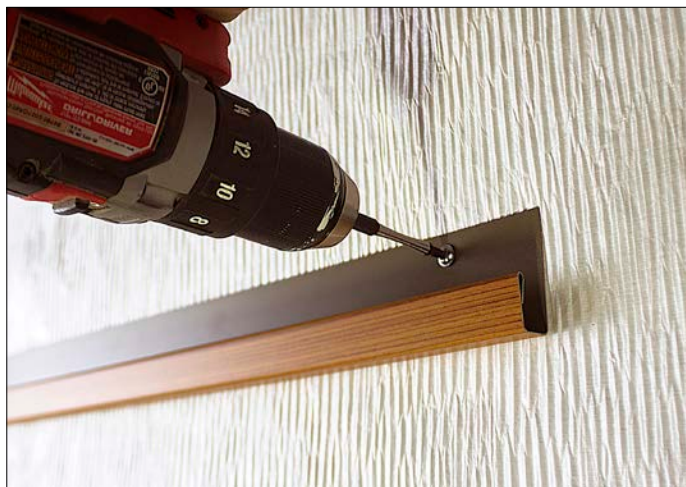

Fig.19

*All walls must be prepared with proper rain screen and vapour barrier that meet local building codes prior to installation of LUX panels.

Install J channels at the top under the eaves or flashing as required (Fig.19).

Begin the panel installation by sliding the panel into the J channel with the screw flange down. Attach panel with appropriate fasteners through screw flange making sure panel is snug into trim. Do not overtighten fastener as panel should be able to float on the wall (Fig.20).



Fig.20

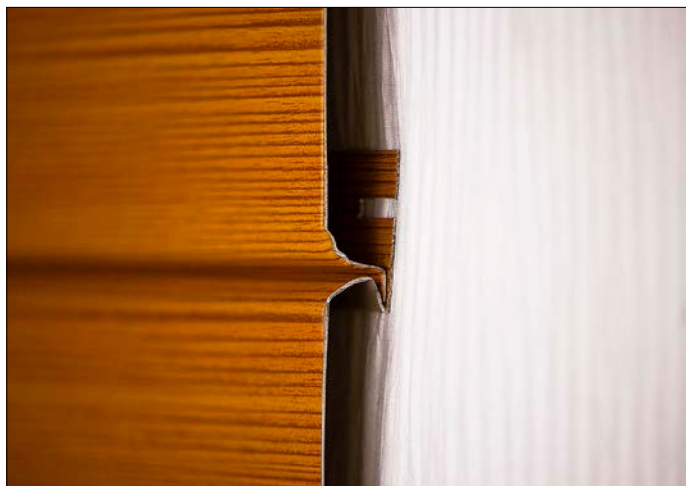

Fig.21

Continue the installation by inserting the next panel's tongue snugly into the groove of the previous panel, ensuring that it is fully seated. Continue until you reach the last piece, which may be trimmed to fit if necessary (Fig.21).

Wall Installation - Vertical

Begin at either end of the wall surface to be covered. Start by placing the panel tongue into the starter or trim piece, attach panel to the wall with the appropriate fastener in the screw flange (Fig.22). Attach LUX screws in the centre of the screw flange while allowing the panel to float on the wall (Fig.23).



Fig.22



Fig.23

LUX panel can be installed snug to the base flashing or placed into the J channel that is installed over the base flashing (Fig.24). Continue the installation by inserting the next panel's tongue snugly into the groove of the previous panel, ensuring that it is fully seated. Continue until you reach the last piece, which may be trimmed to fit if necessary (Fig.25).



Fig.24

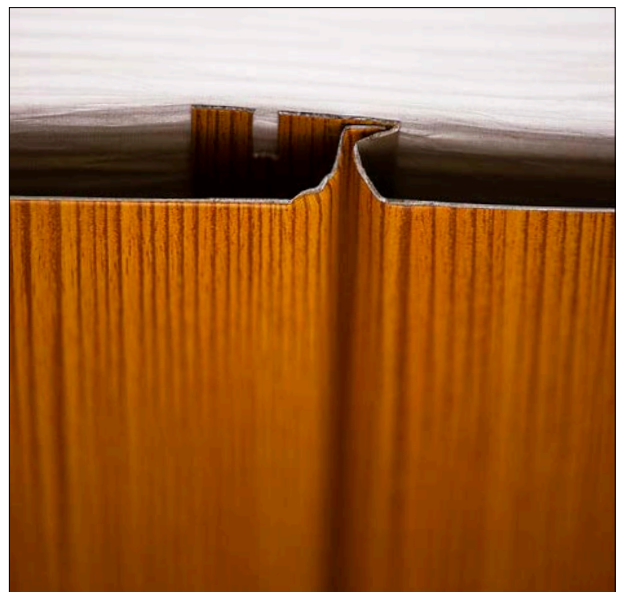

Fig.25

Wall Installation - Finishing Panels

Finishing the last panel horizontally or vertically.

*Horizontal Installation is demonstrated and vertical installation is similar.

Step 1: Measure from the last panel into inside edge of finishing trim, subtract 1/16" from measurement (Fig.26).

Step 2: Then use measurement to cut panel through its full length (Fig.27).



Fig.26



Fig.27

Step 3: After cutting the panel, you will have the finished cut piece and the surplus off-cut (Fig.28).

Step 4: Use the off-cut as an inside support for the trimmed panel (Fig.29).

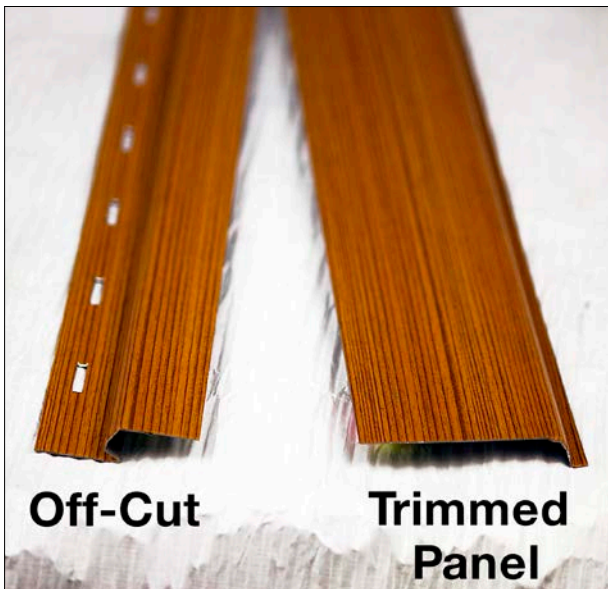

Fig.28

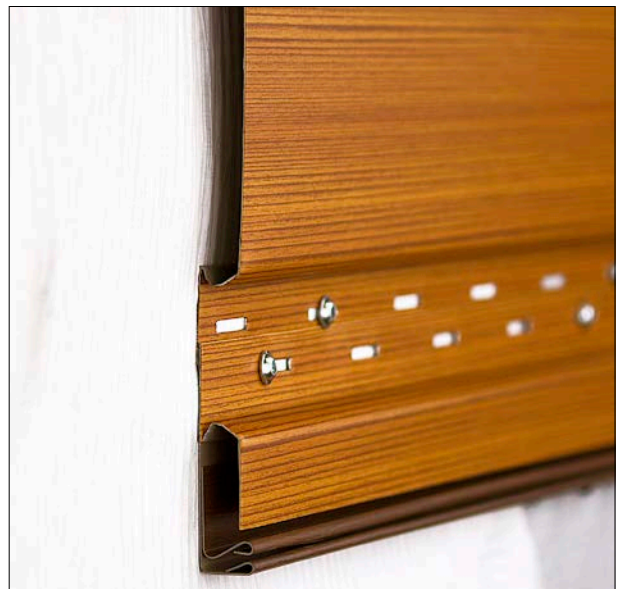

Fig.29

Wall Installation - Finishing Panels

Finishing the last panel horizontally or vertically.

*Horizontal Installation is demonstrated and vertical installation is similar.

Step 5: Add small amount of silicone sealant between the finished panel and the underside off-cut support panel (Fig.30).

Step 6: Install the off-cut piece into trim with the cut portion against the inside edge of the trim piece (Fig.31).



Fig.30

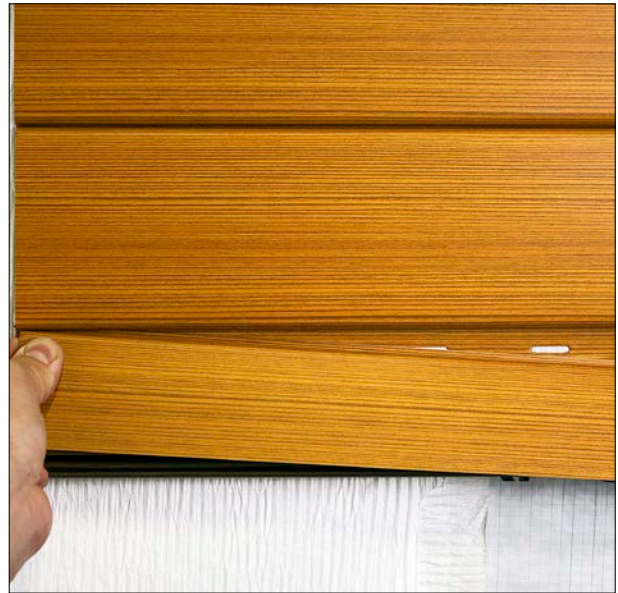

Fig.31

Step 7: Snap top cover of two piece J into place by applying pressure or tapping with a rubber mallet (Fig.32).

Step 8: Ensure the trim is seated and flush with panel (Fig.33).

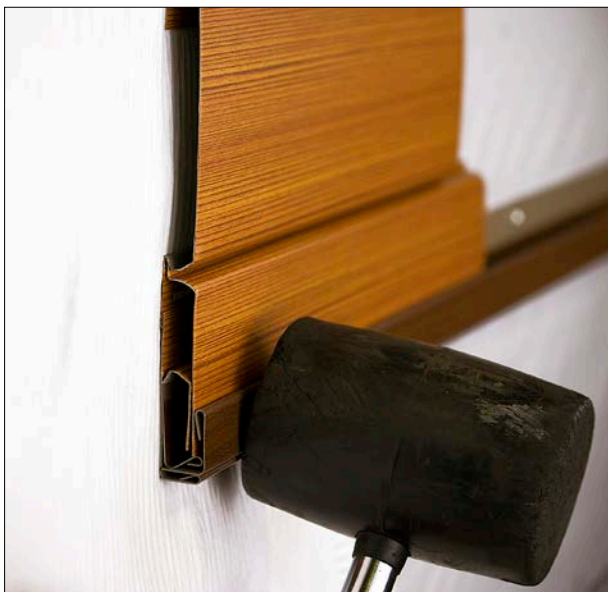

Fig.32

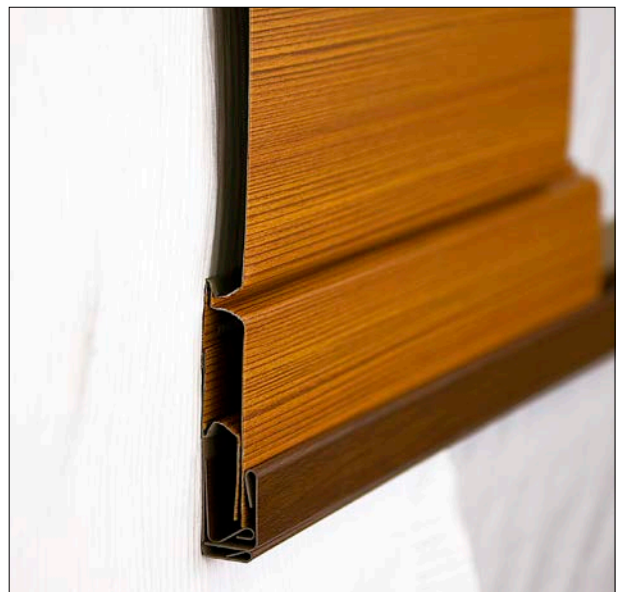

Fig.33

Wall Installation - Trimming Panels

2 Piece J Channel - The top and bottom J channel are designed to go together to finish panel sections where it is necessary to add the trim after the panels have been installed (Fig. 37).



Fig.34



Fig.35

Step 1: Install the two piece J base section as required on one side or bottom of wall (Fig.34).

Step 2: Set standard panels in place and fasten (Fig.35).

Step 3: Finish installation by installing the top cover of the two piece J (Fig.36).

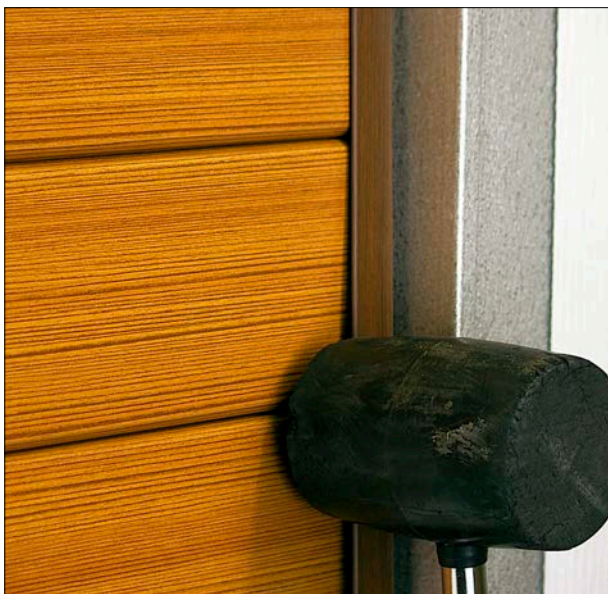

Fig.36

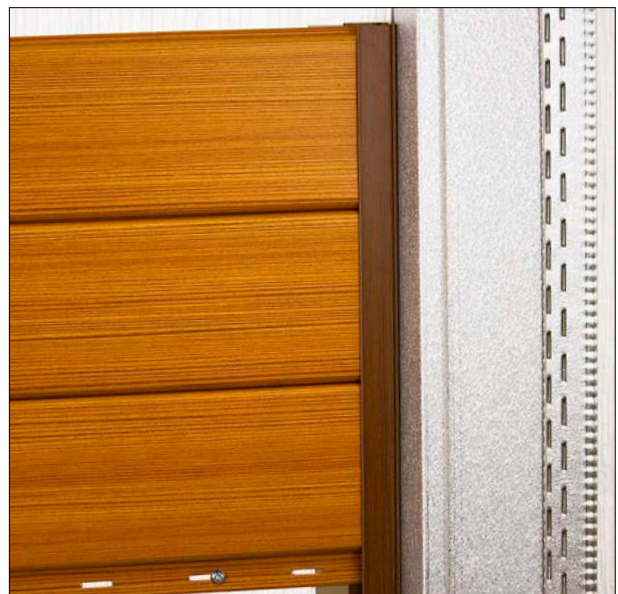

Fig.37

Wall Installation - Trimming Panels

Two Piece Joiner J - The two piece Joiner J channel and closure are designed to go together to finish panel sections where it is necessary to add the trim after the panels have been installed (Fig.38). The Closure #705 is part of the water dispersion design (Fig.39) + (Fig.41).

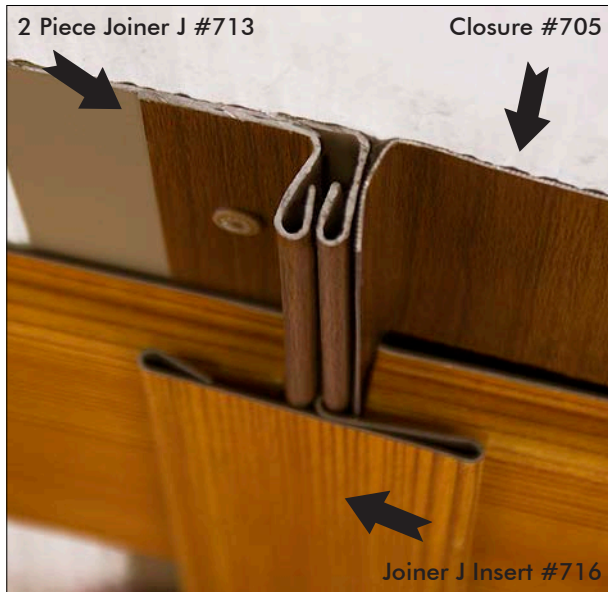

Fig.38

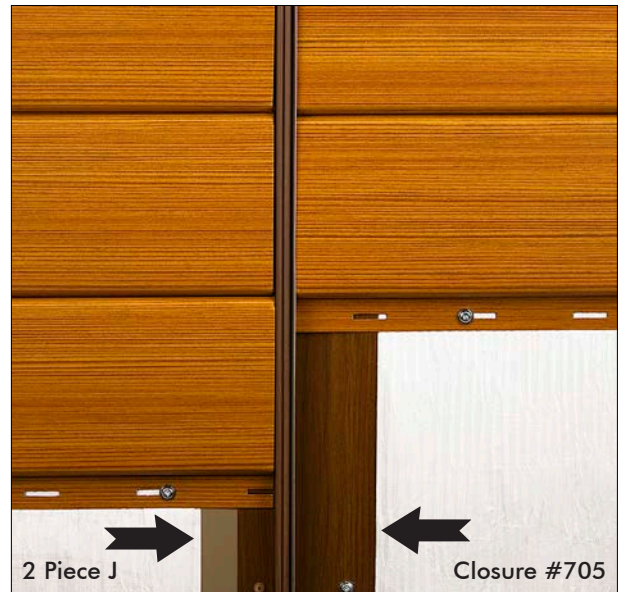

Fig.39

Step 1: Install the two piece Joiner J and closure back to back (Fig.39) + (Fig.41).

Step 2: Set the standard panels in place and fasten (Fig.39).

Step 3: Finish installation by installing the Joiner J Insert #716 (Fig.41).

The finished installation will provide you with a clean aesthetic that also accommodates water drainage (Fig.38).

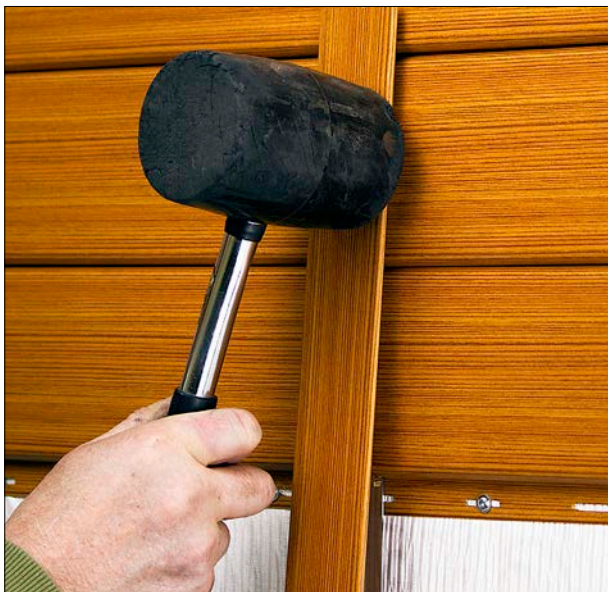

Fig.40

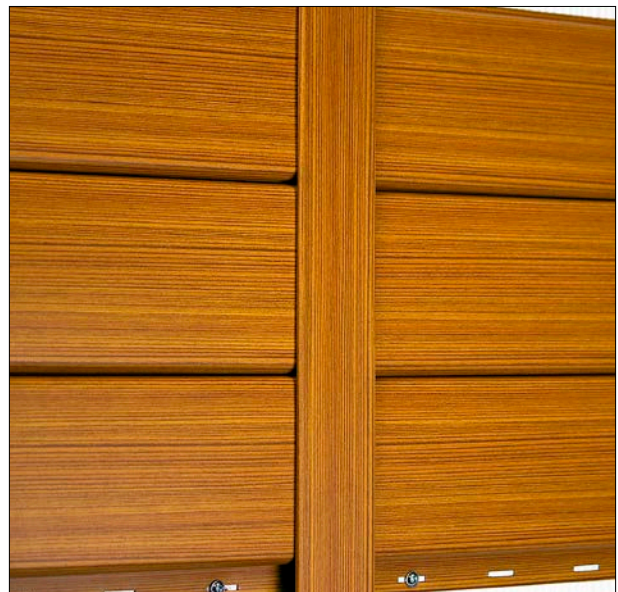

Fig.41

Wall Installation - Trimming Panels

Joiner J - is used as required to join the panel sections together or as a transition moulding between the LUX panel and another surface.

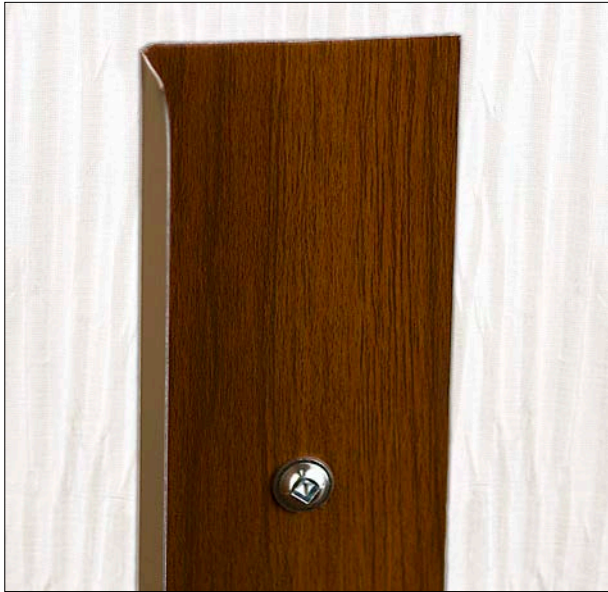

Fig.42



Fig.43

Step 1: Set closure (#705) in Place (Fig.42).

Step 2: Set standard panels in place and fasten (Fig.43).

Step 3: Set the Joiner J (#708) in place and fasten (Fig.44).

Step 4: Set the standard panels in place and fasten (Fig.45).

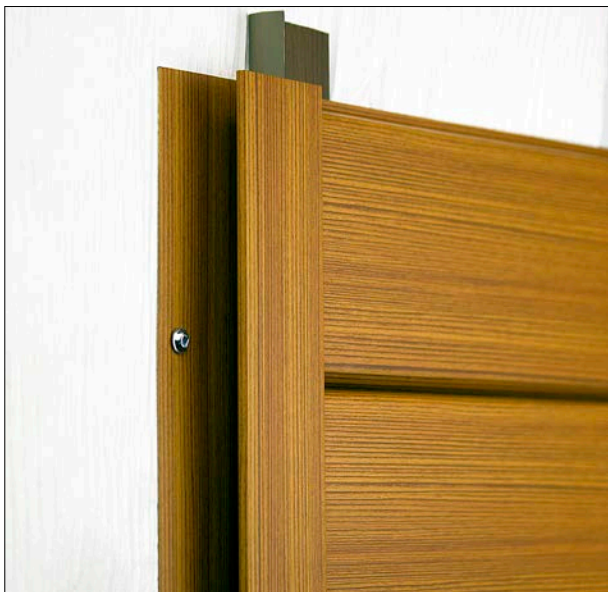

Fig.44

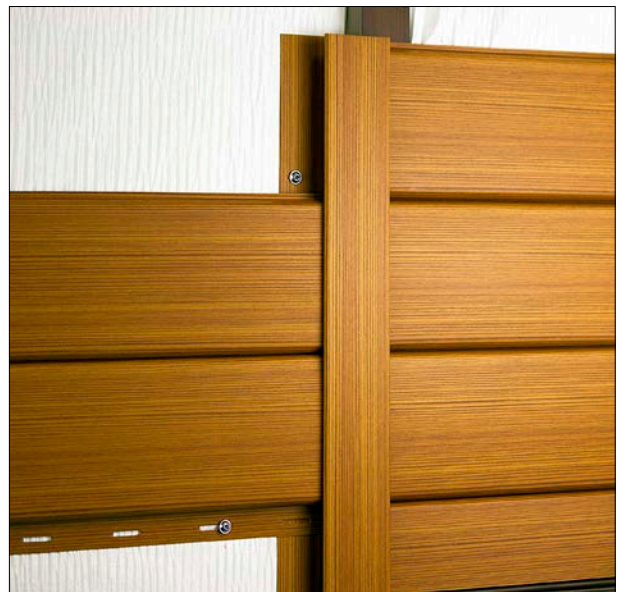

Fig.45

Wall Installation - Trimming Panels

The joiner J is used as required to join panel sections together (Fig.46).

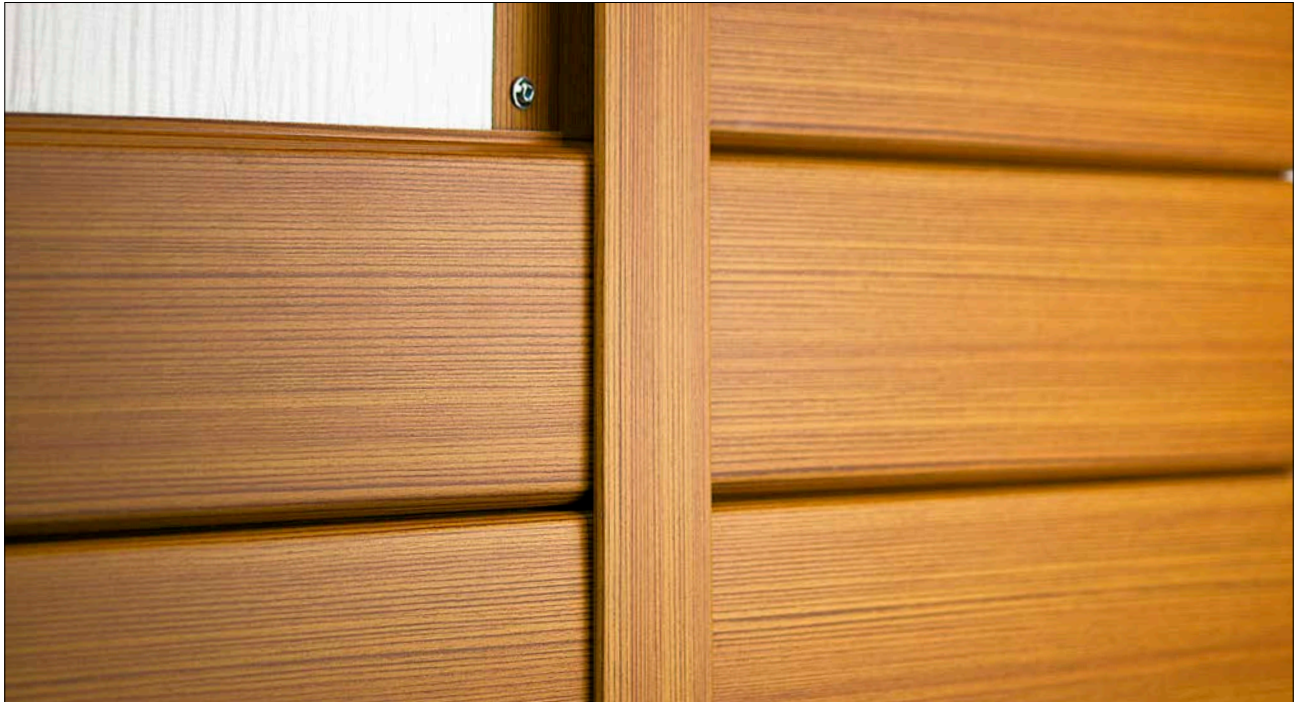

Fig.46

The joiner J is also used as a transition moulding between LUX panel and another surface of the same thickness (Fig.47).

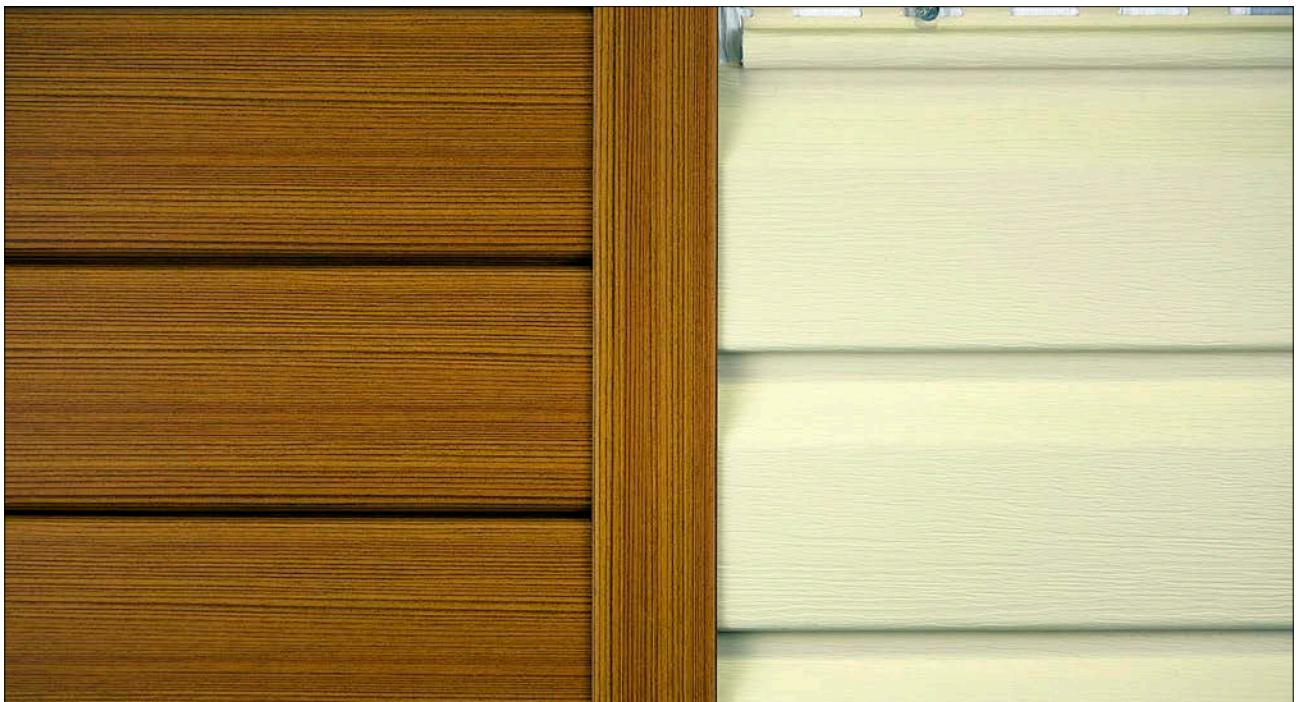

Fig.47

Wall Installation - Trimming Panels

Drip Cap - Installed over openings such as windows and doors to protect against water penetration. End of cap must be finished to meet local building codes. Vapour barrier is applied over drip-cap but not demonstrated in the photo guide. To start the installation of the drip cap it must first be “damned” to accommodate the size of your opening.



Fig.48

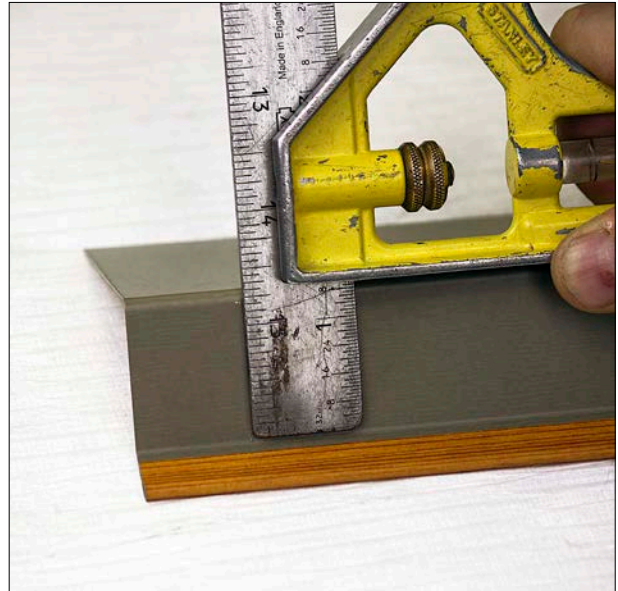

Fig.49

Step 1: Measure 1” from the drip cap end and mark (Fig.48).

Step 2: Measure 1” from the drip-cap base (Fig.49).

Step 3: Trim the drip-cap at 20 degree angle (Fig.50).

Step 4: Using your hemming pliers bend in towards the drip cap surface (Fig.51).



Fig.50



Fig.51

Wall Installation - Trimming Panels

Step 5: Pre-drill then attach the drip cap (#709) to a surface (Fig.52).

Step 6: Attach J Channel (#703) to the surface around drip cap (Fig.53).



Fig.52



Fig.53

Step 7: Install the panel leaving space for a trimmed panel. Use an off-cut as support for the trimmed panel (Fig.54).

Step 8: Set the trimmed and standard panels in place and fasten (Fig.55).

* Finished Drip Cap should resemble image (Fig.55).



Fig.54

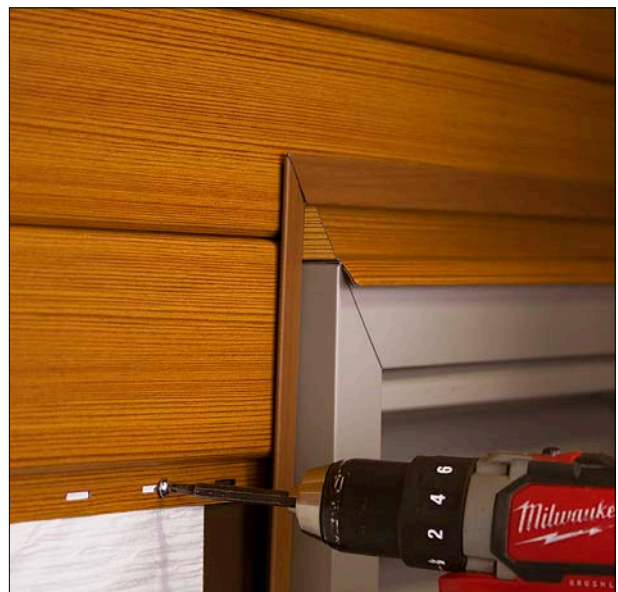

Fig.55

Wall Installation - Full Corners

Install corners prior to the installation of LUX panels as demonstrated in the following diagrams. Install on inside and outside corners as required. When installing LUX panels in a vertical application start at the inside or outside corner and work towards the open trim. When installing panels on a closed wall with two corners, install inside corner or outside corner on one end, then install panels and trim on other end over top such as an open corner.

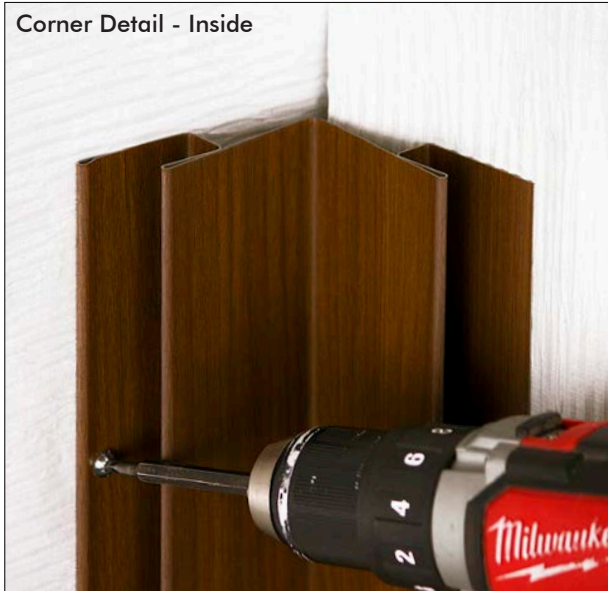

Fig.56

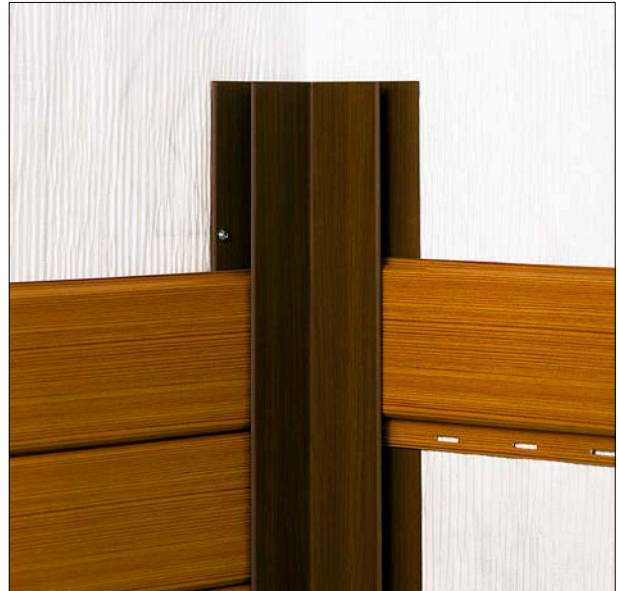

Fig.57

Inside corner:

Step 1: Set the inside corner (#707) in place and fasten (Fig.56).

Step 2: Set the standard panels in place and fasten (Fig.57).

Outside corner:

Step 1: Set the outside corner (#706) in place and fasten (Fig.58).

Step 2: Set the standard panels in place and fasten (Fig.59).

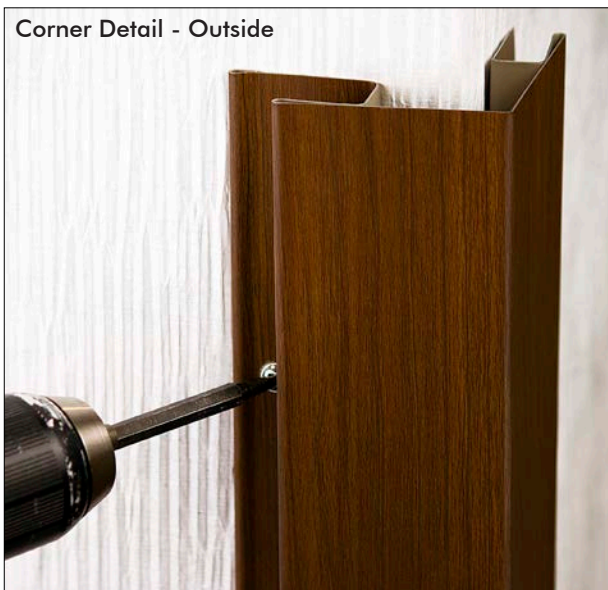

Fig.58

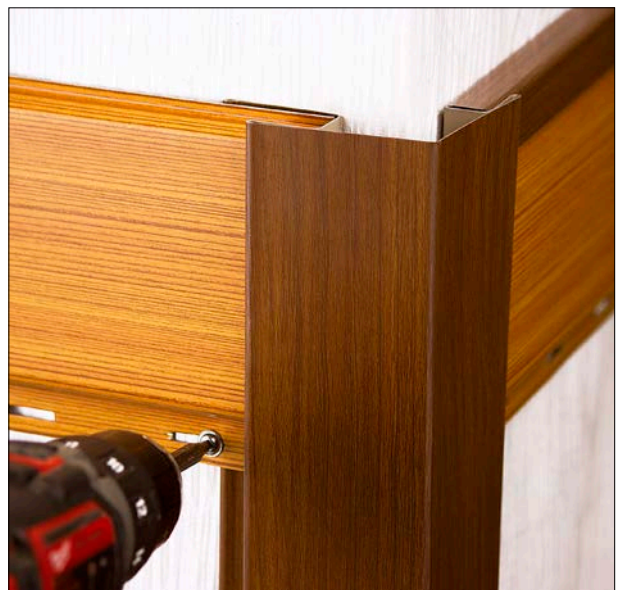

Fig.59

Wall Installation - Open Corners

Open Inside Corners - Use as an end of wall trim installed after the panel, or as a transition moulding between LUX panel and a finished wall with a different material.

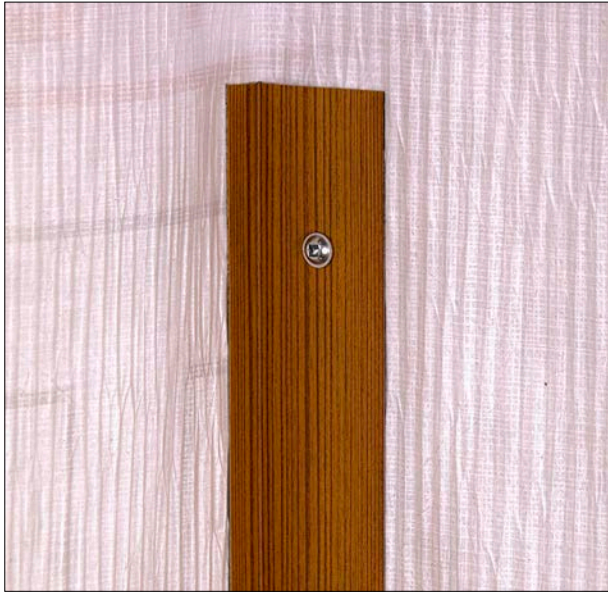

Fig.60



Fig.61

Step 1: Set the closure trim (#705) in place (Fig.60).

Step 2: Set the standard panels in place and fasten (Fig.61).

Step 3: Set the open inside corner (#712) in place and fasten (Fig.62).

Step 4: Set the standard panels in place and fasten (Fig.63).

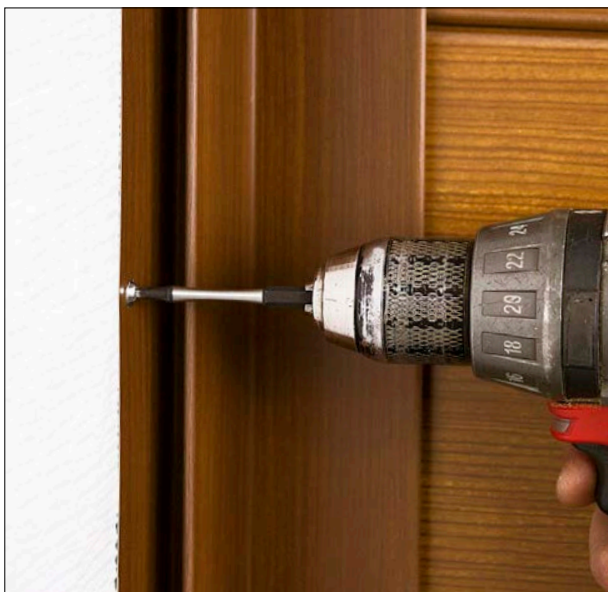

Fig.62

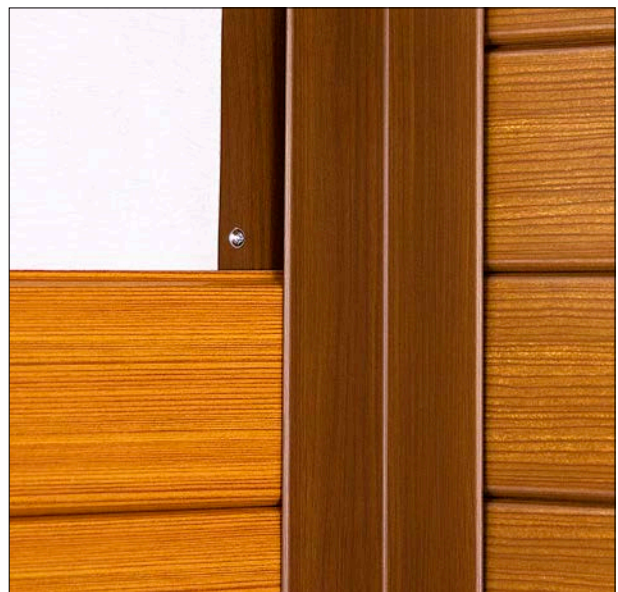

Fig.63

Wall Installation - Open Corners

Open Outside Corner

Step 1: Set the closure trim (#705) in place (Fig.64).

Step 2: Set the standard panels in place and fasten (Fig.65).



Fig.64

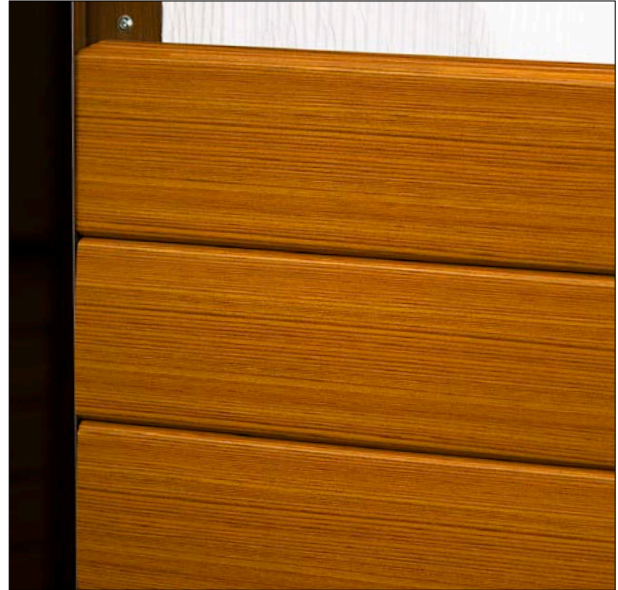

Fig.65

Step 3: Set the open outside corner (#711) in place and fasten (Fig.66).

Step 4: Set the standard panels in place and fasten (Fig.67).

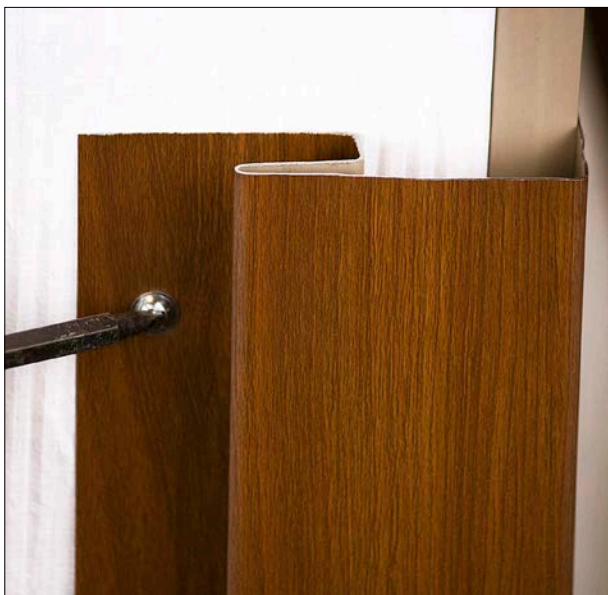

Fig.66

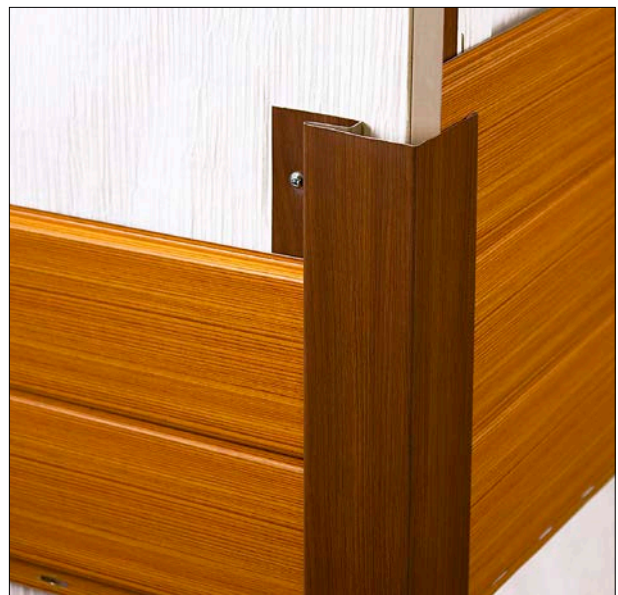

Fig.67

Wall Installation - Snap T Corners

Inside & Outside Snap T Corner - The exclusive LUX Snap T corner combines a small face profile with high strength and durability. As a result of ongoing research, development and innovation this corner is our most highly recommended corner. The following images demonstrate the recommended installation steps of the Snap T corner. The profile of the outside Snap T corner is demonstrated in Figure 68 as well as a completed install in Figure 69.



Fig.68

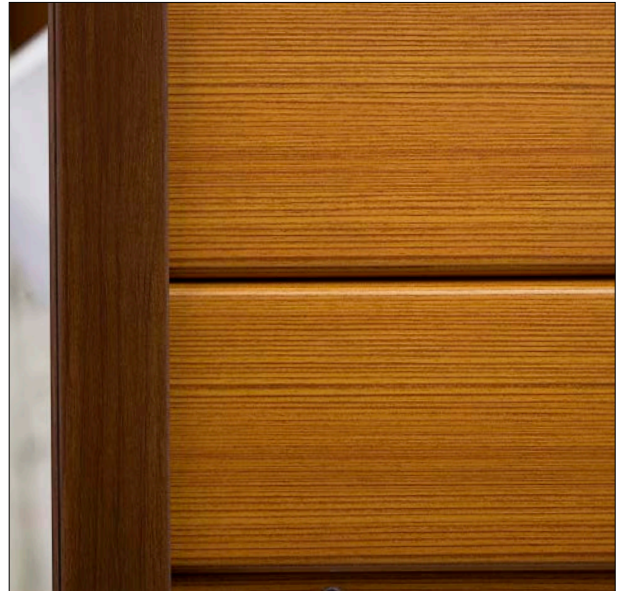

Fig.69

Step 1: Pre-drill installation holes at a minimum of 10 inches apart. (see Fig.70).

Step 2: Ensure that the corners of the LUX Snap T corner are square with the substrate of the wall then fasten with specified screw (Fig.71).



Fig.70

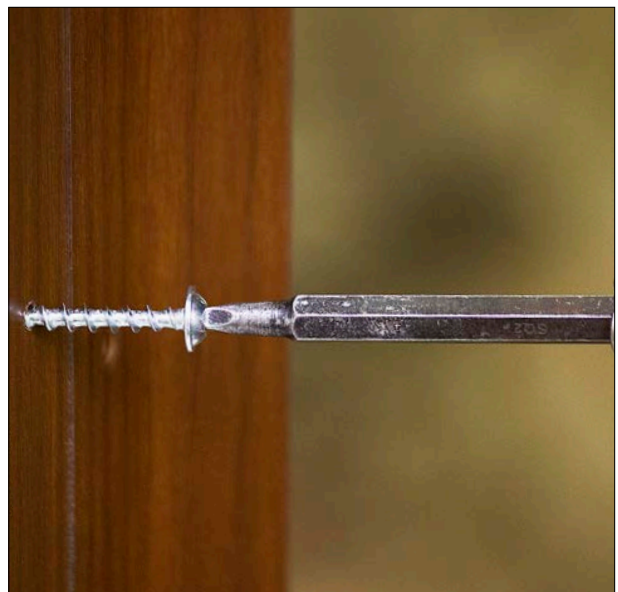

Fig.71

Wall Installation - Snap T Corners

Step 3: Because the LUX Snap-T is a truly straight and accurate corner, variations in the substrate will have to be accommodated for when installing the corner. Shimming may be required to adjust for substrate variances and in order to guarantee that the ends are flush with each other and are aligned for the installation of cover trims (Fig.72).



Fig.72



Fig.73

Step 4: Install the standard panels and fasten (Fig.73).

Step 5: Place one end of the Snap T corner in the channel and apply pressure to snap into place (Fig.74).

Step 6: Place the other end of the Snap T corner in the channel and apply pressure until snug (Fig.75).

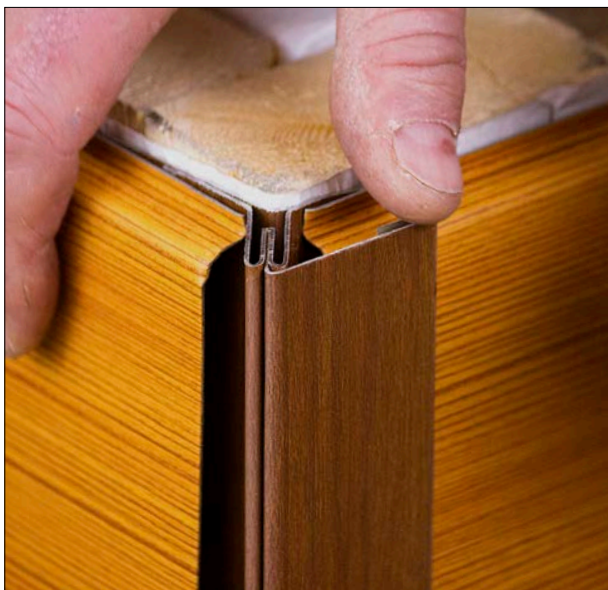

Fig.74

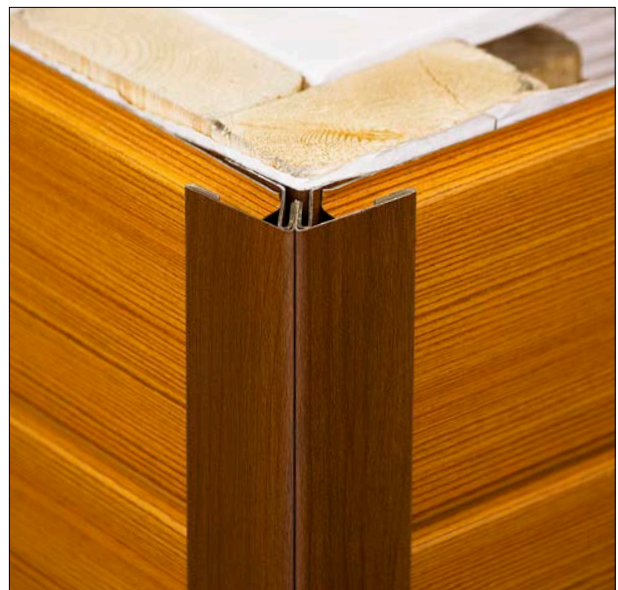

Fig.75

Wall Installation - Snap T Corners

Inside Snap T Corner 45 - The exclusive LUX Snap T corner 45 gives a unique narrow angle to an inside finished corner. Figure 76 demonstrates the unique profile of the Snap T 45 and its innovative design. Figure 77 demonstrates the aesthetic of the finish Snap T 45 and the clean lines of the finished product.

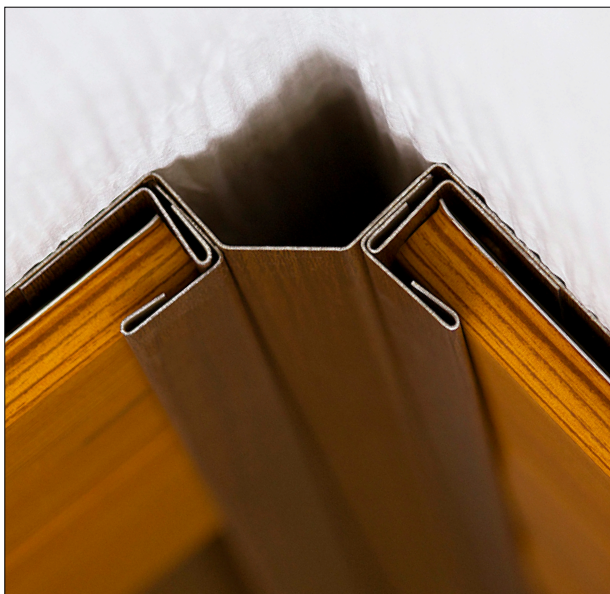

Fig.76

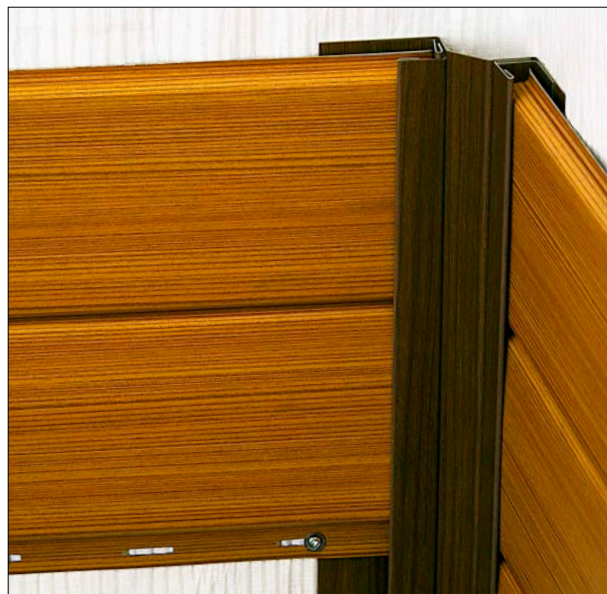

Fig.77

Step 1: Pre-drill installation holes at a minimum of 10 inches apart. (see Fig.78).

Step 2: Ensure that the corners of the LUX Snap T corner are square with the substrate of the wall then fasten with specified screw (Fig.79).



Fig.78

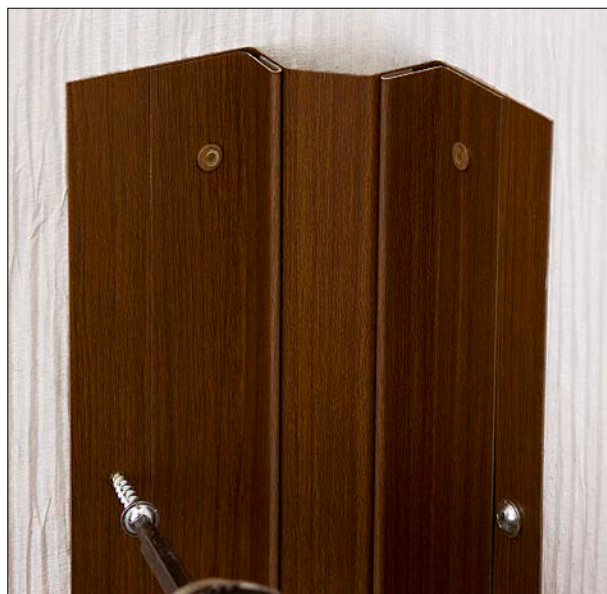

Fig.79

Wall Installation - Snap T Corners

Step 3: Because the LUX Snap T is a truly straight and accurate corner, variations in the substrate will have to be accommodated for when installing the corner and shimming may be required to adjust for substrate variances.
Step 4: Install standard panels and fasten (Fig.80).

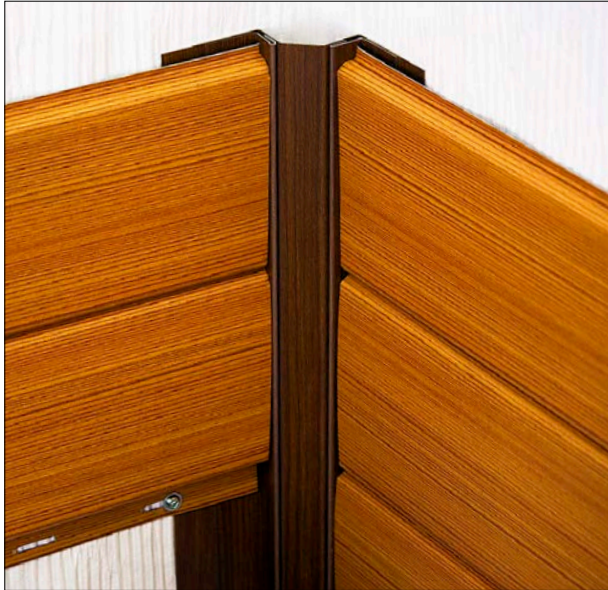

Fig.80



Fig.81

Step 5: Place one end of the Snap-T corner in channel and gently into place tap with rubber mallet (Fig.81).
Step 6: Place the other end of the Snap-T corner in channel and gently into place tap with rubber mallet (Fig.82).
Step 7: Ensure that the corner pieces are snug and correctly aligned for your application (Fig.83).

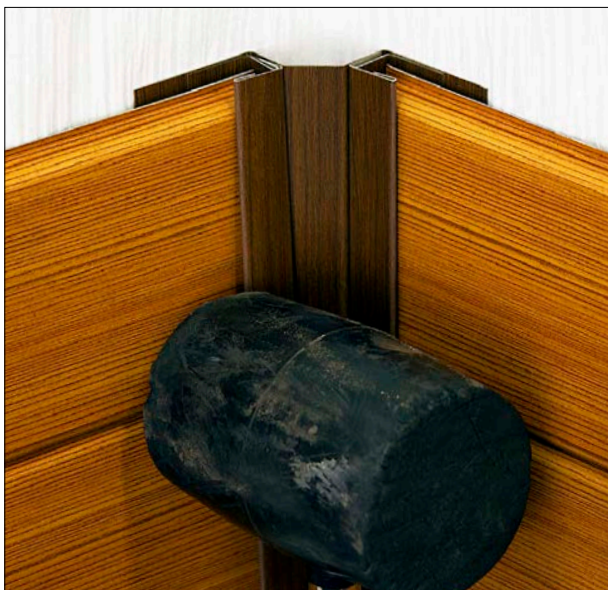

Fig.82

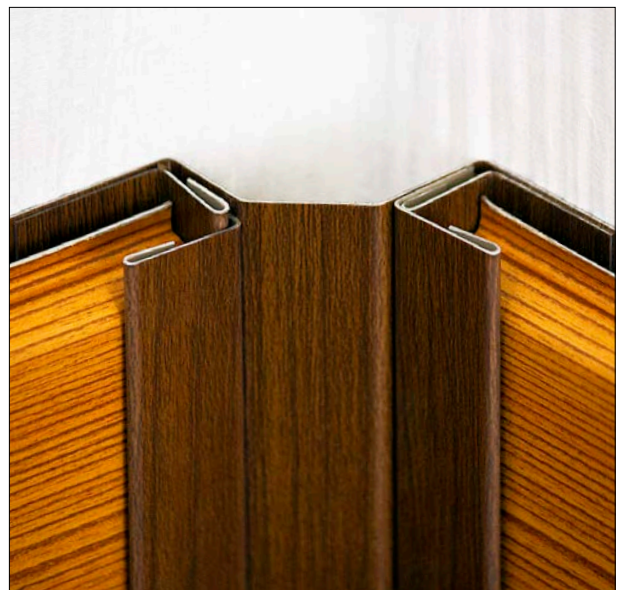

Fig.83

Installation Tips + Best Practices

- Although highly consistent in colour and pattern, ordering all LUX panels and trims at the same time will ensure colour continuity throughout the project. LUX panel wood-print finish is produced in batches which may have slight shade variations between orders from different batches. Ordering a couple of extra panels and trims, in case of damage or a wrong cut, is standard practice and can save time and money for the overall project.
- LUX panel is manufactured from cold rolled pre-finished steel which gives it superior strength and durability, however, LUX panel can be damaged due to undo care or excessive pressure when fitting or handling.
- During the manufacturing process, the ends of the panels can be slightly compressed. Either cut the tongue of the next panel to be fitted at an angle, or place a flat screwdriver in the compressed end and twist open. See figure 13 + 14 on Page 2 of the installation guide.
- Overtightening fastening screws and not being diligent placing the screws in the center of the screwing slots can cause the panel to deflect and possibly show "oil canning".
- Whenever possible, always pre-drill and install with specified screws.
- If there is a need for soffit but joints, they should be made with factory cut edges only.
- The screw pattern for soffit that runs parallel with the building should be fastened at maximum 24" and siding applications (vertical or horizontal) should have a maximum spacing of 24" on center.
- ***NEVER use a grinder to cut. It will damage material and void the warranty.**



Trims and Finishing

V-Groove 6" Panel

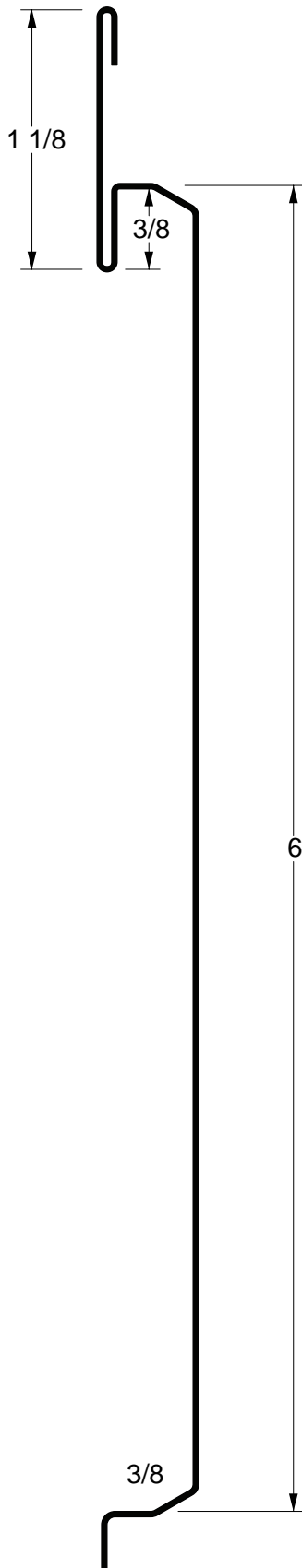

V-Groove 4" Panel

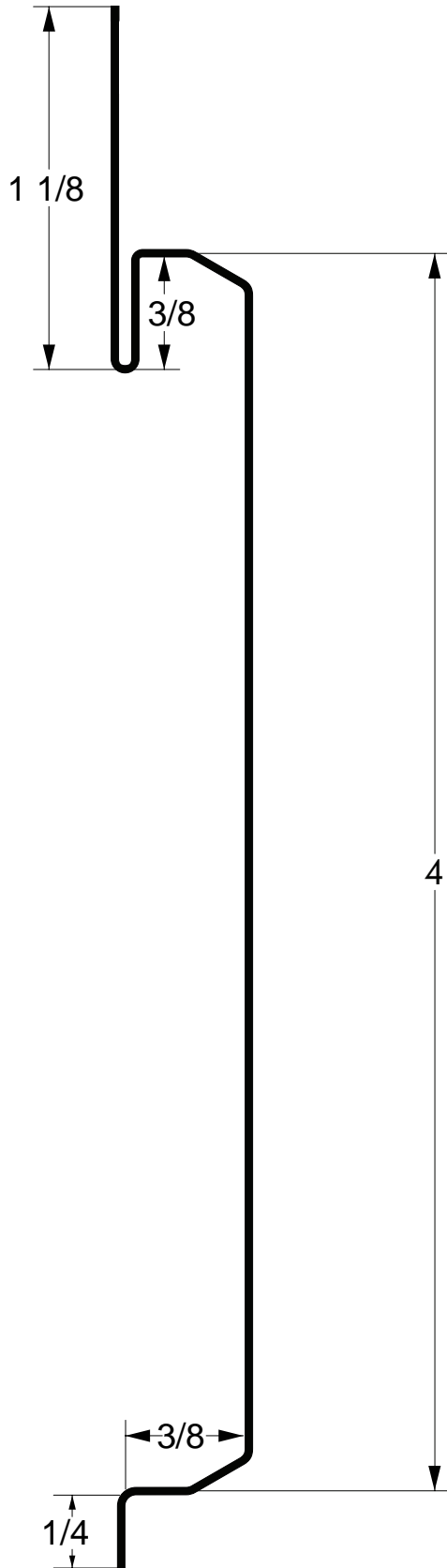

V-Groove Vented 4" Panel

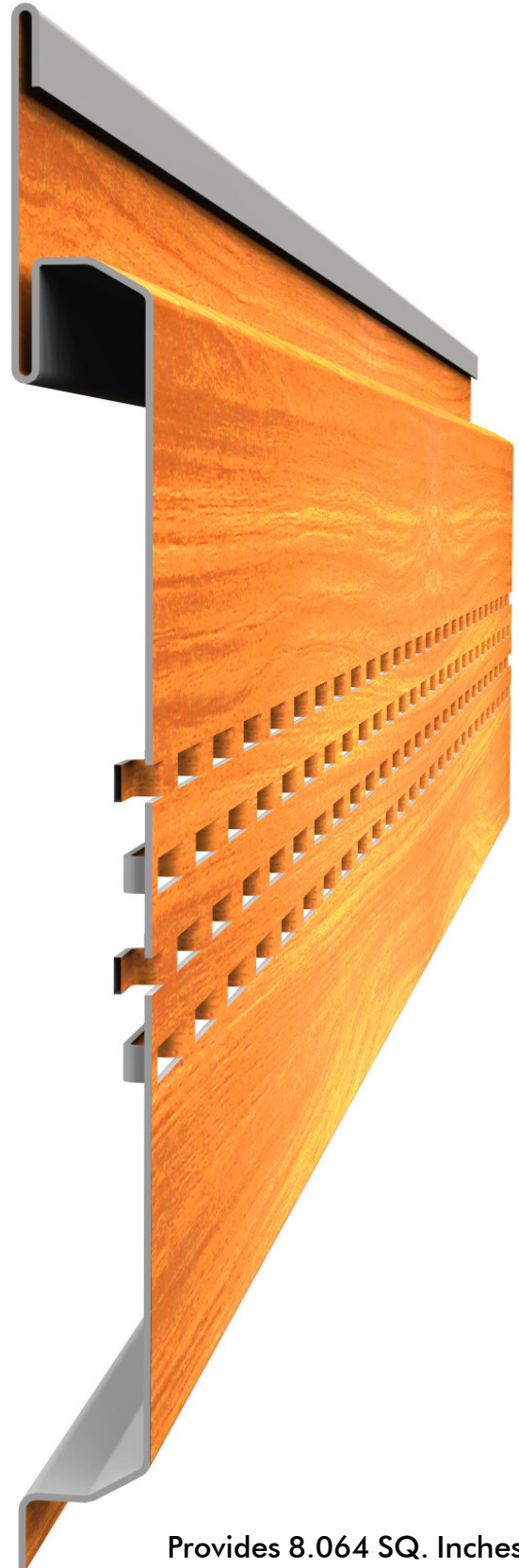
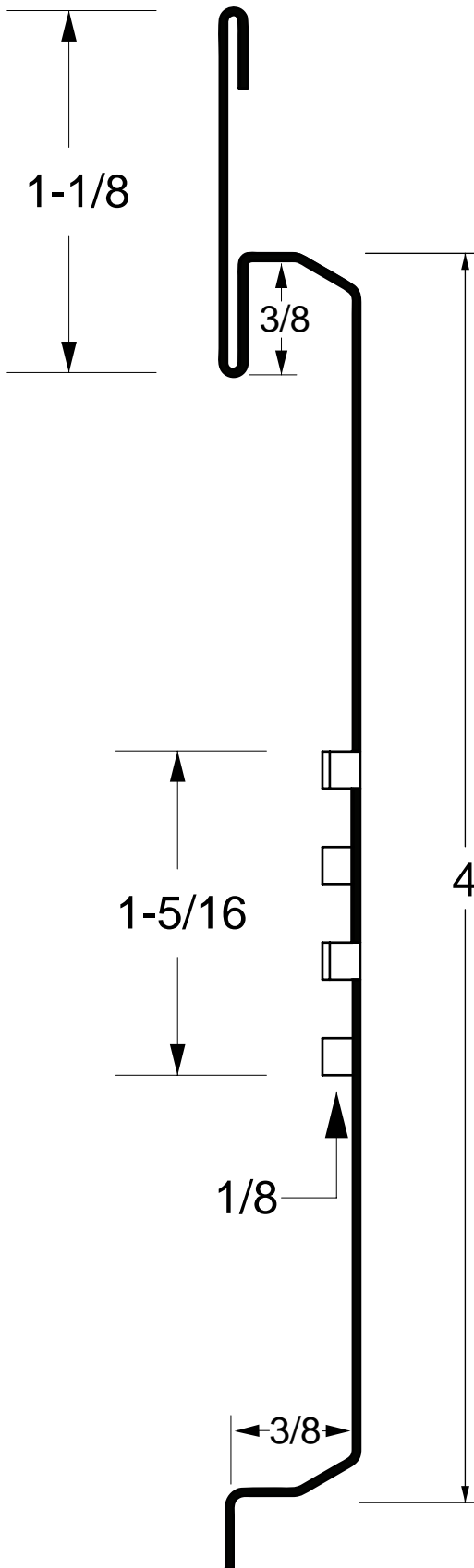

Provides 8.064 SQ. Inches of Venting per square foot

Double 7 - Two Panel Vented Soffit

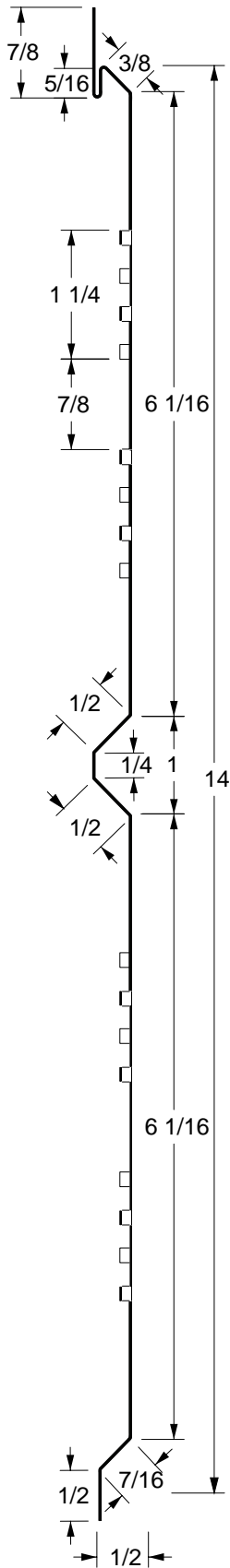

Provides 5.376 SQ. Inches
of Venting per Linear Foot.
Provides 4.6 SQ. Inches of
Venting per Square Foot.

Double 7 - Two Panel Smooth Soffit

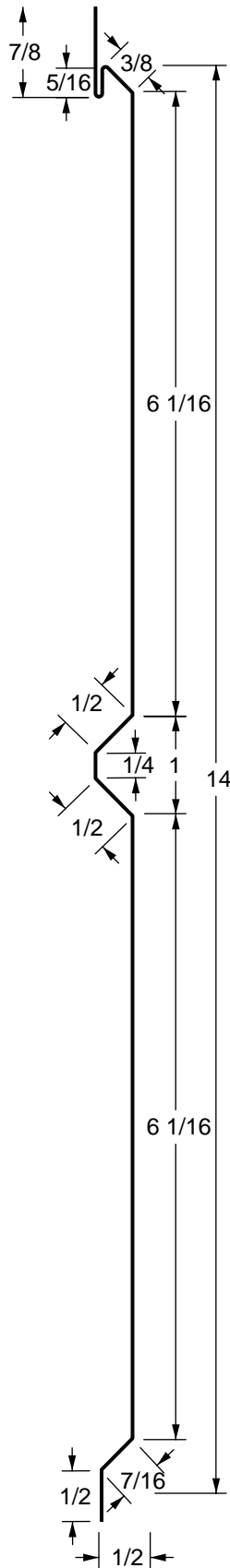

Starter Strip #701

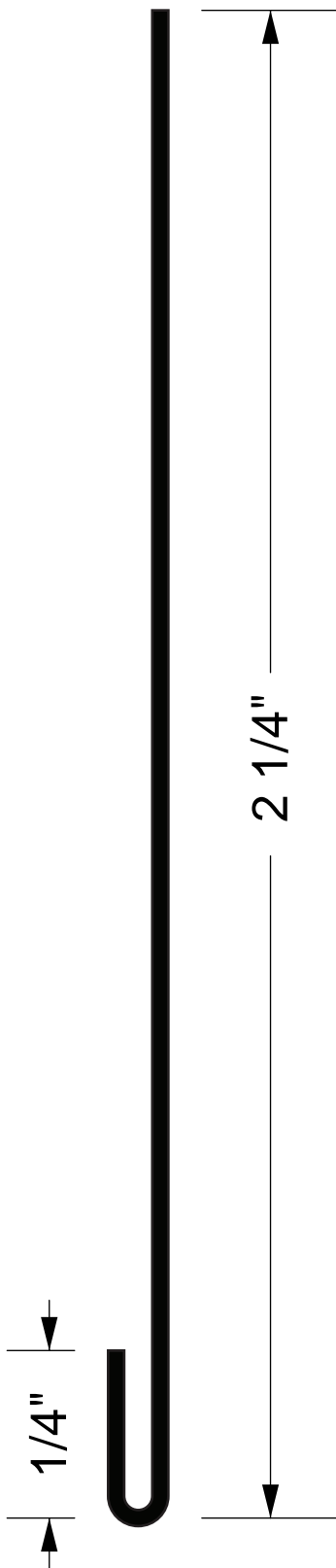

Base Trim #702

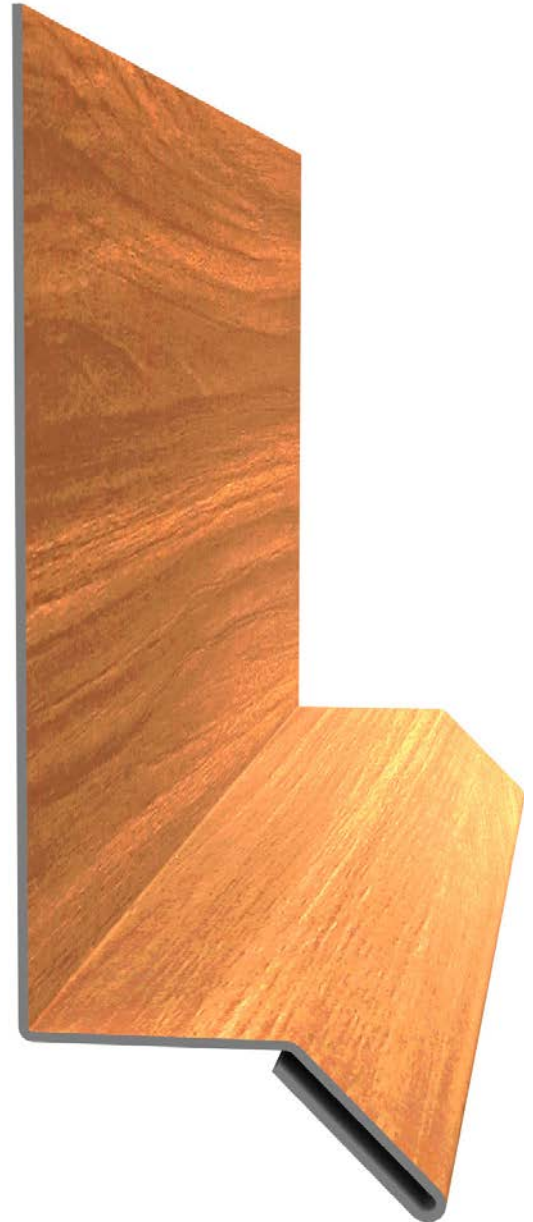
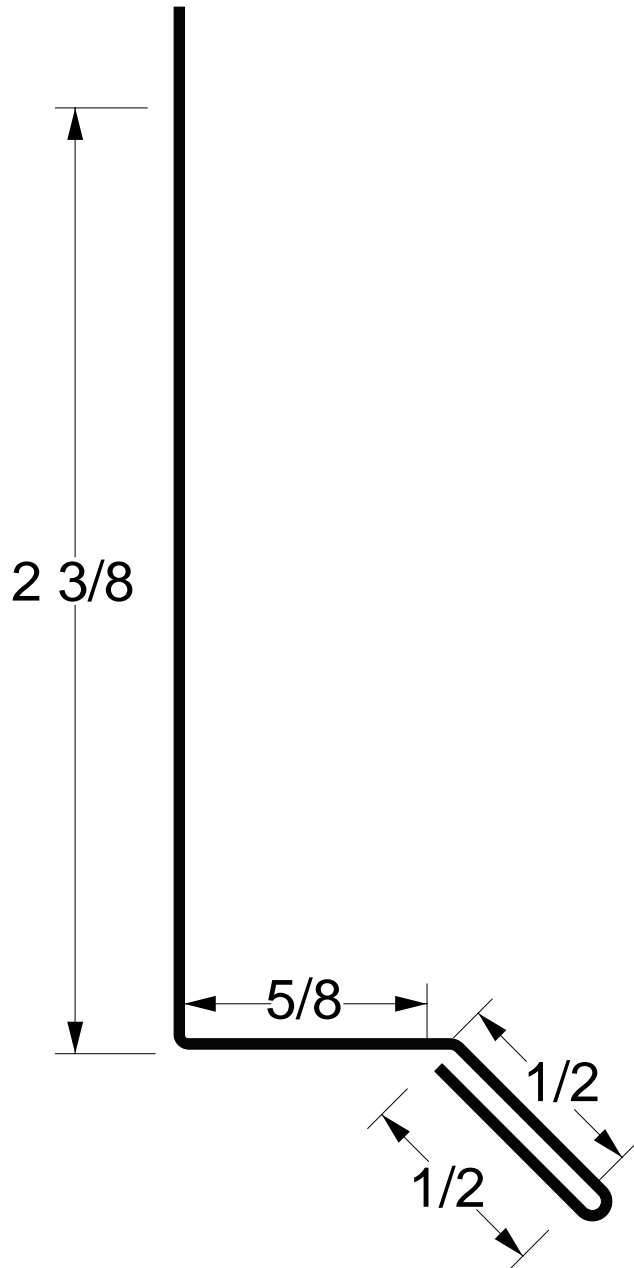

J Channel #703

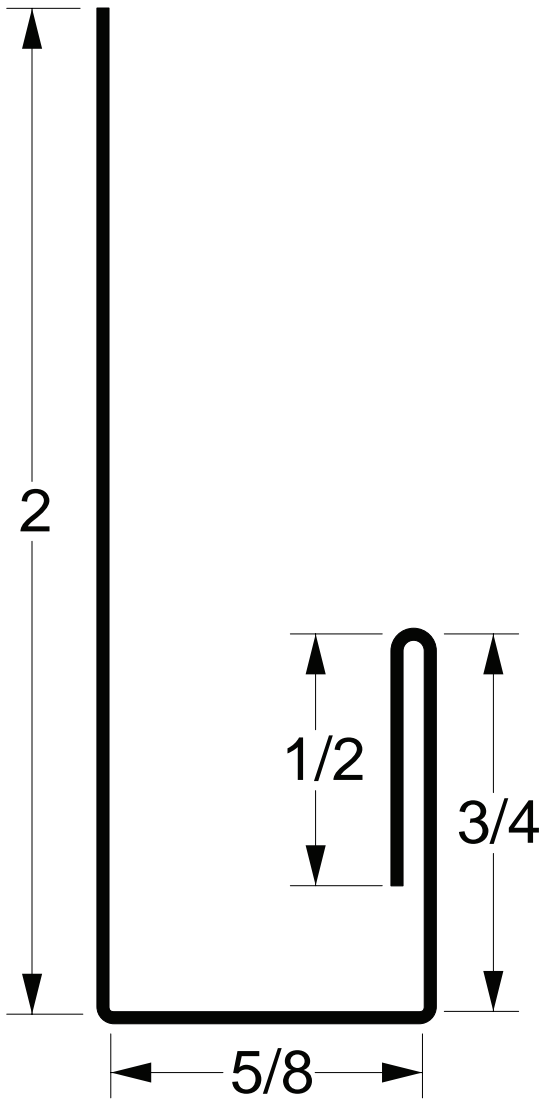

Top J Channel Insert #704

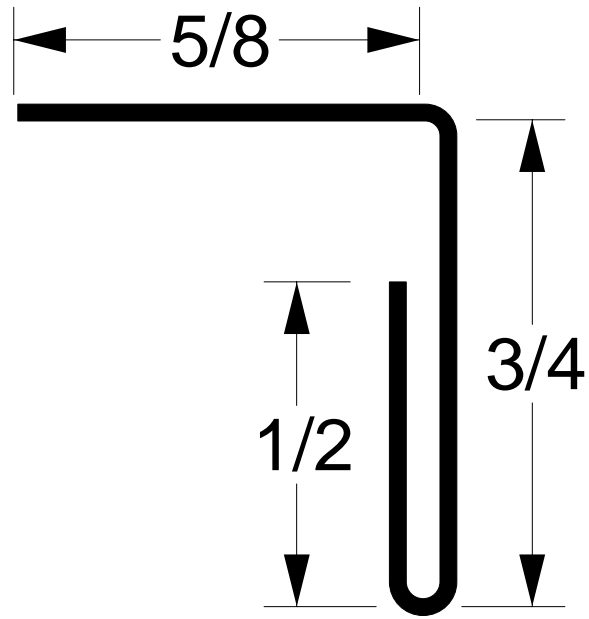

Hidden Closure #705



Outside Corner #706

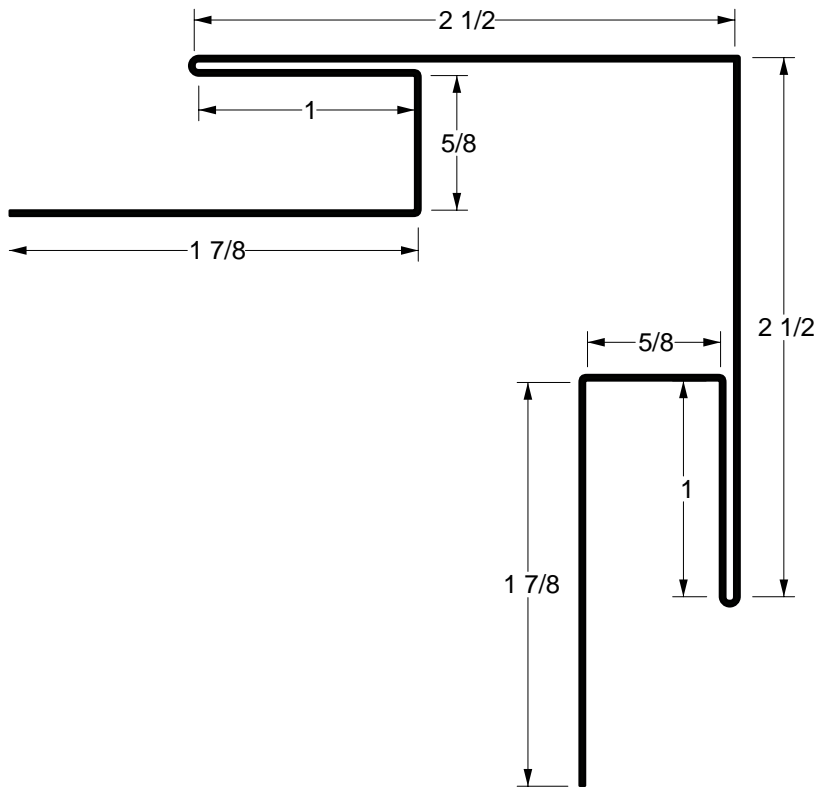

Inside Corner #707

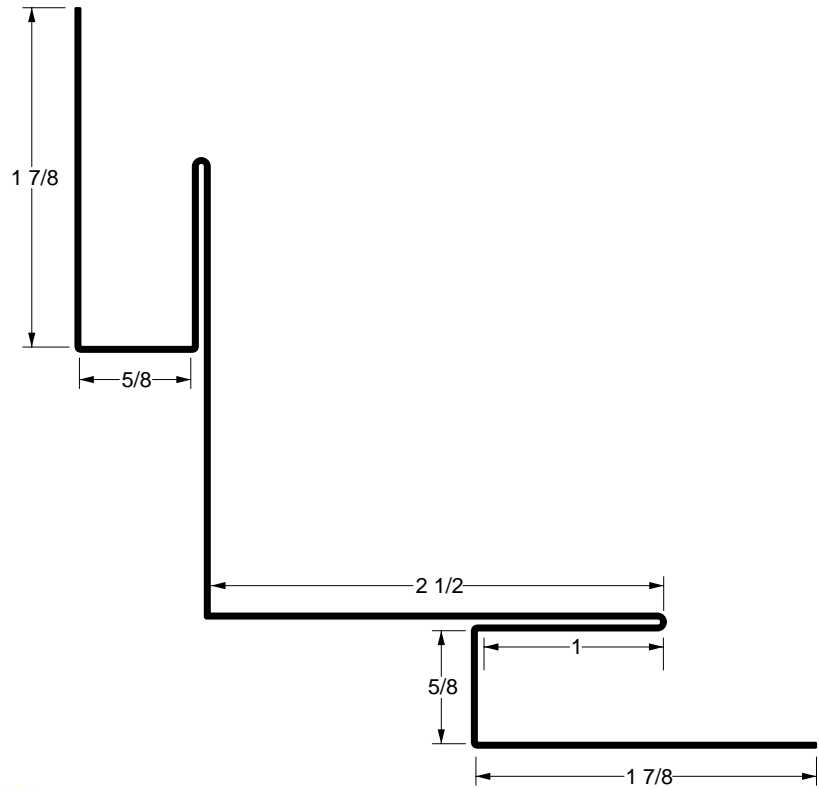

Joiner J #708

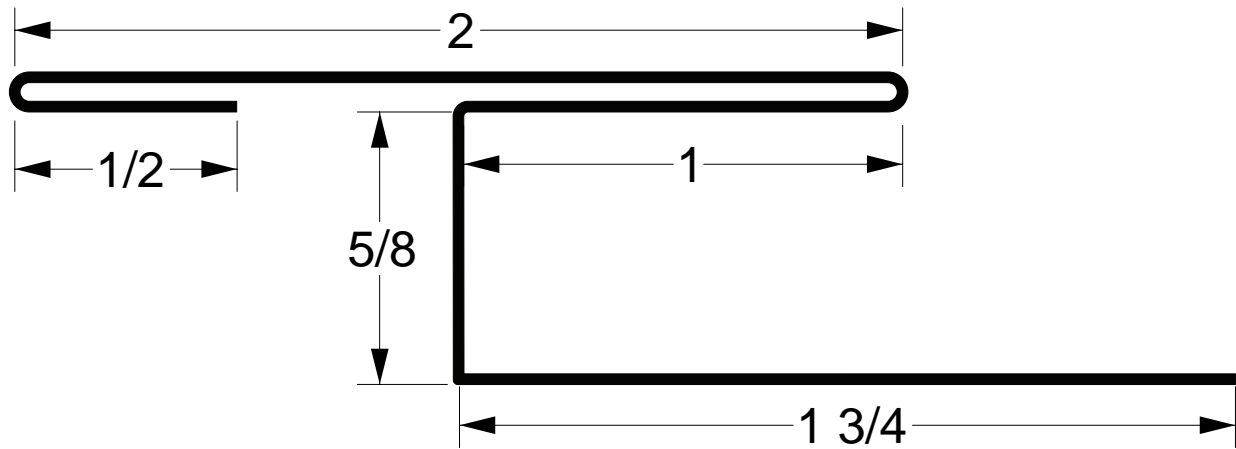

Drip Cap #709

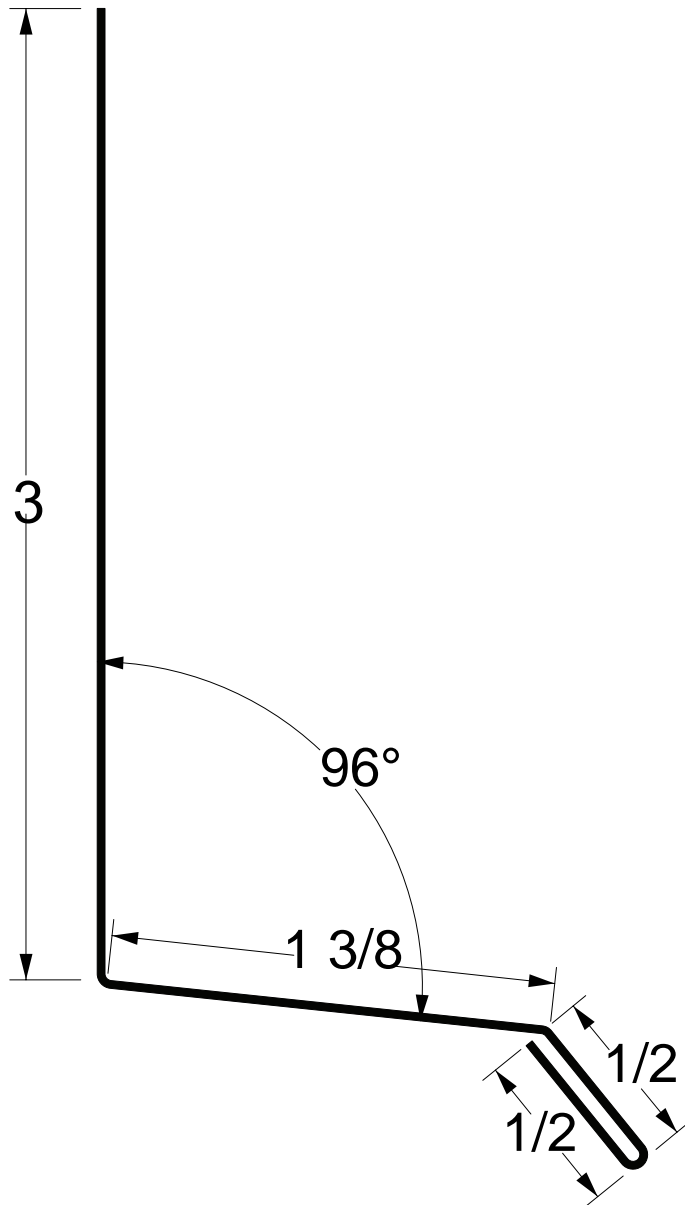

Window Batten #710

*Window Batten can be made in any width from 3" to 6"

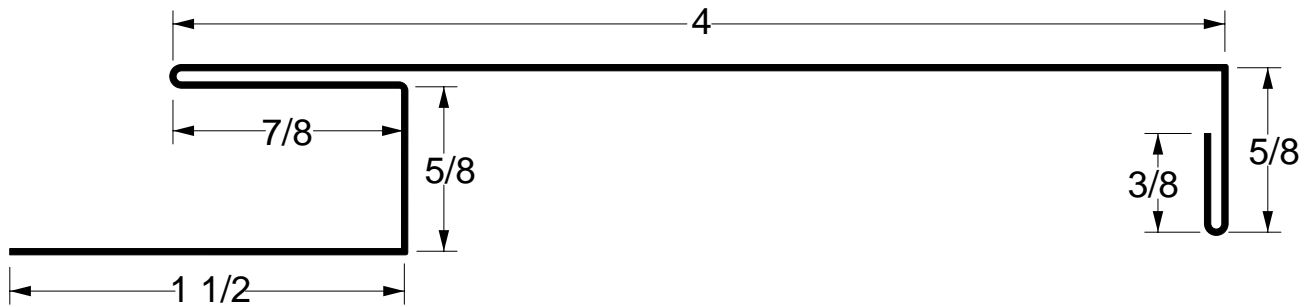

Open Outside Corner #711

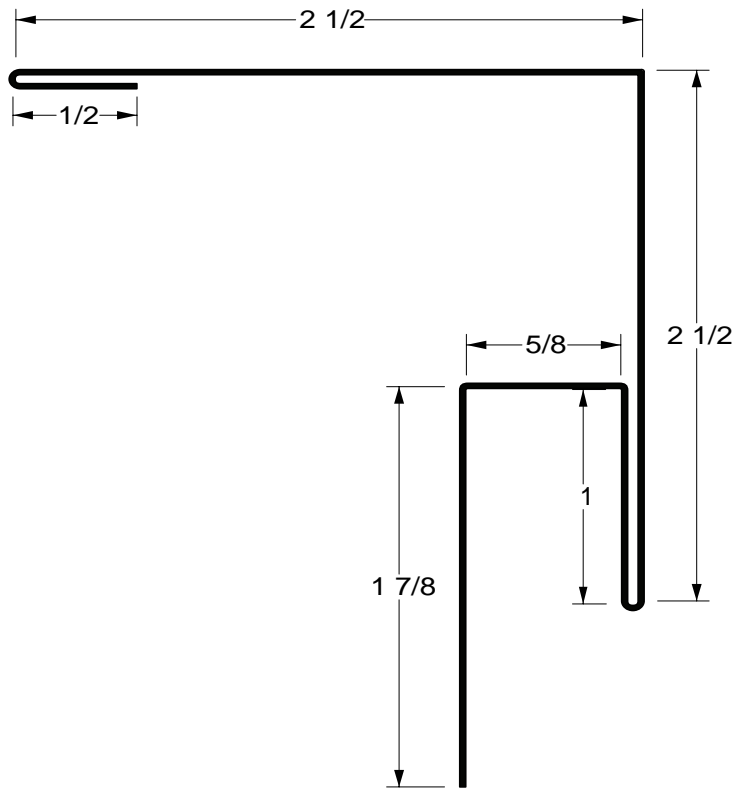

Open Inside Corner #712

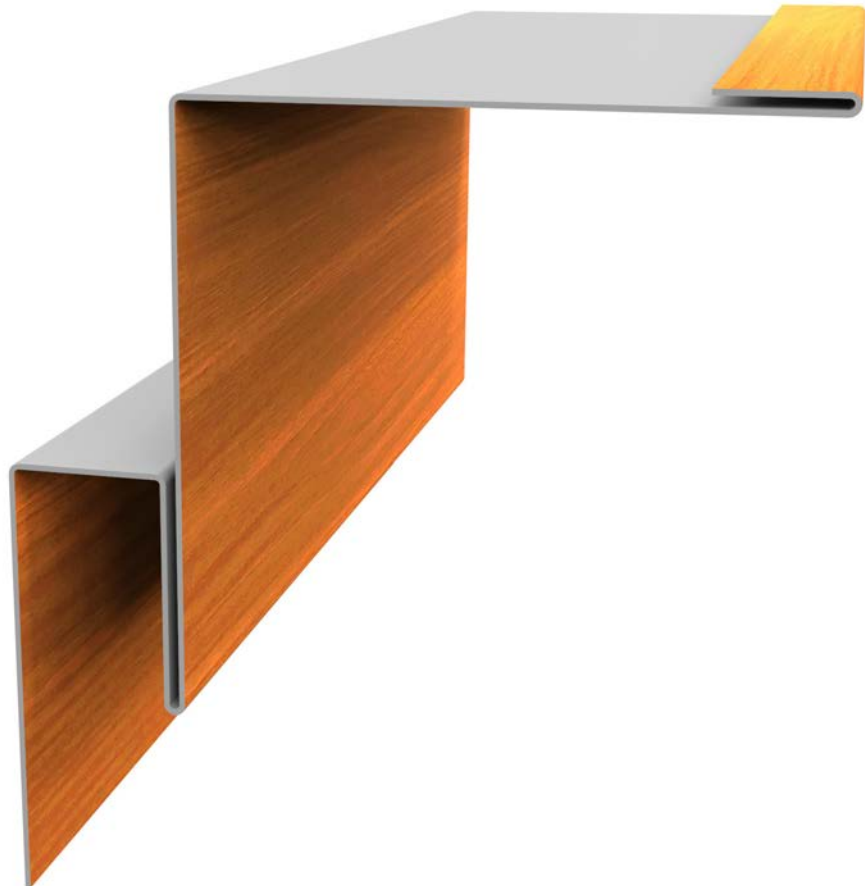
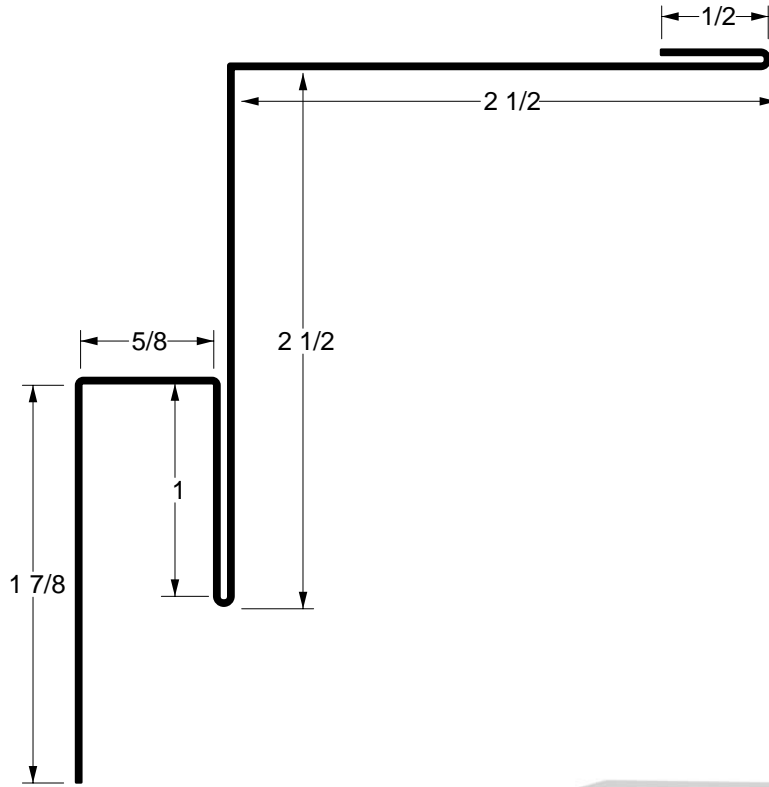

Bottom J Receiver #713

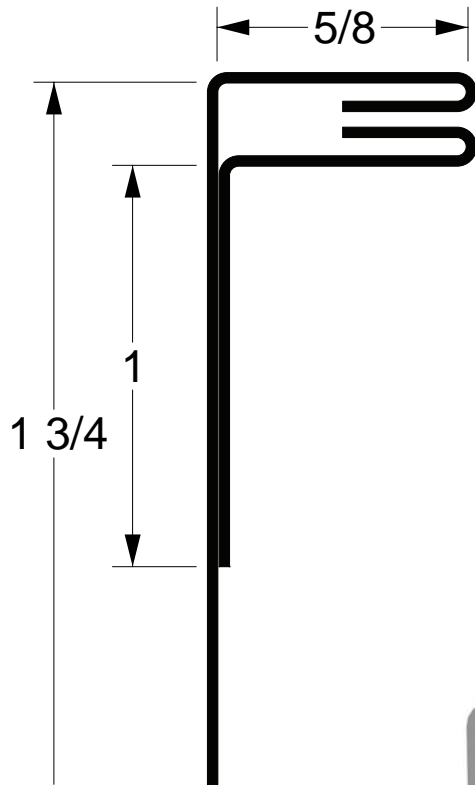

Snap-T Outside Corner #714

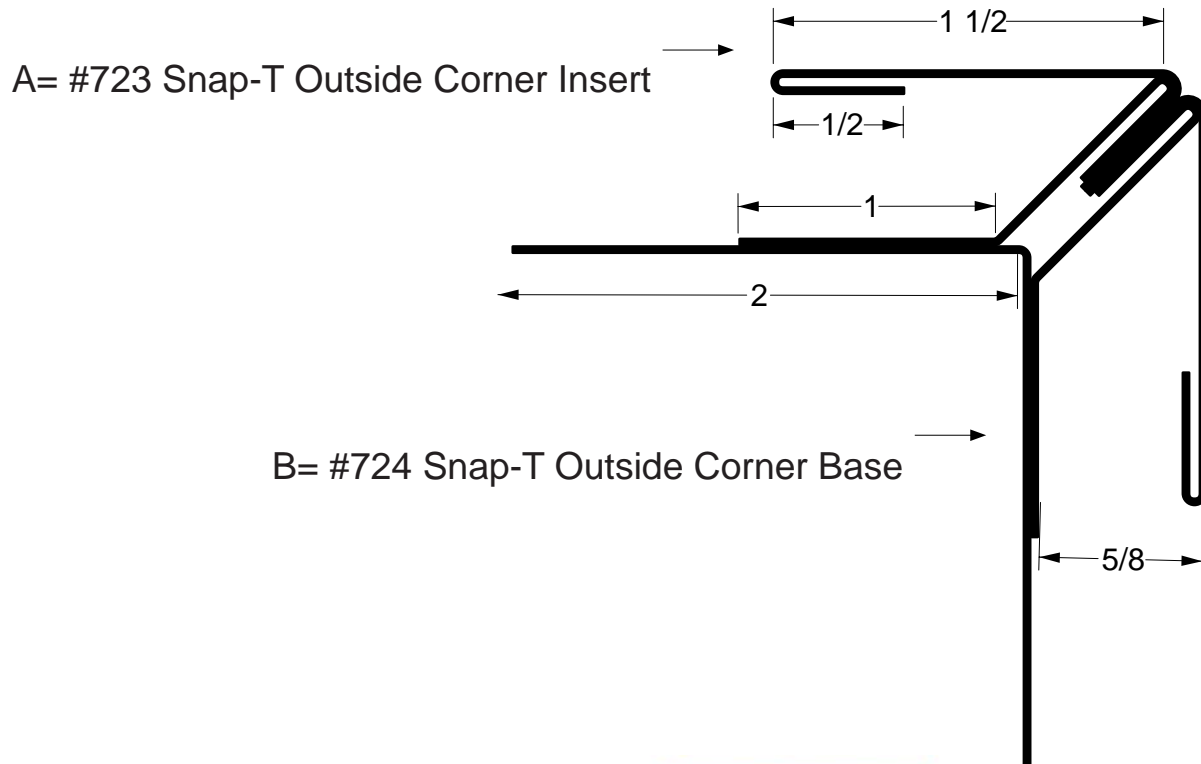

Two Piece J-Channel #715

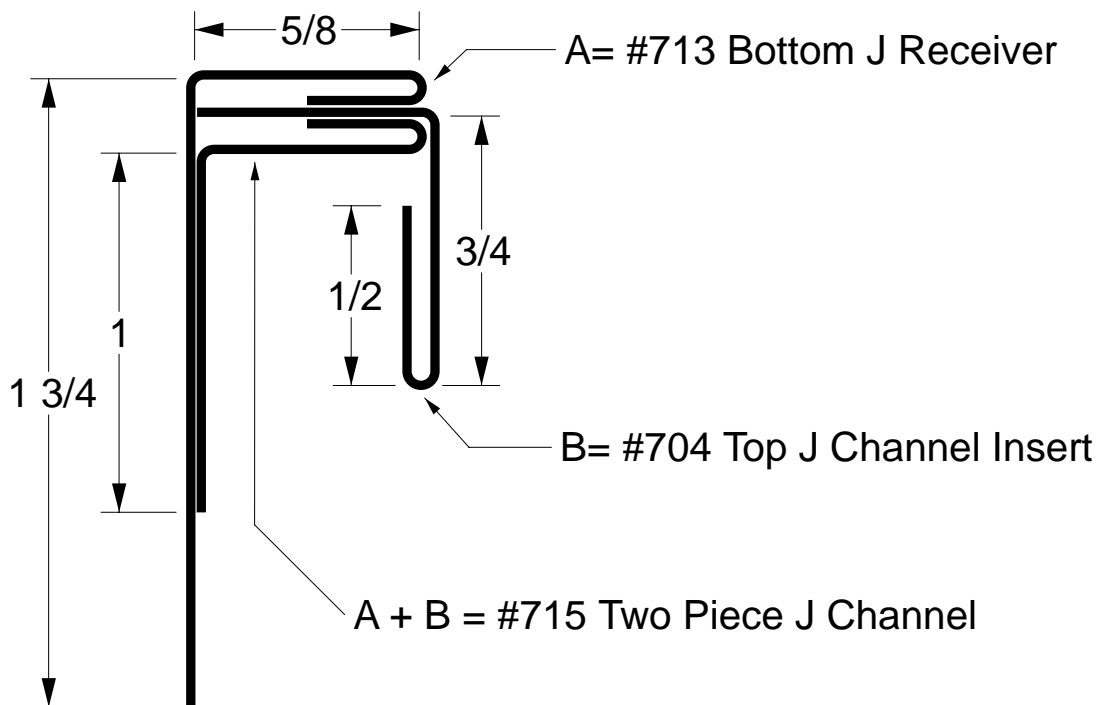

Joiner J Insert #716

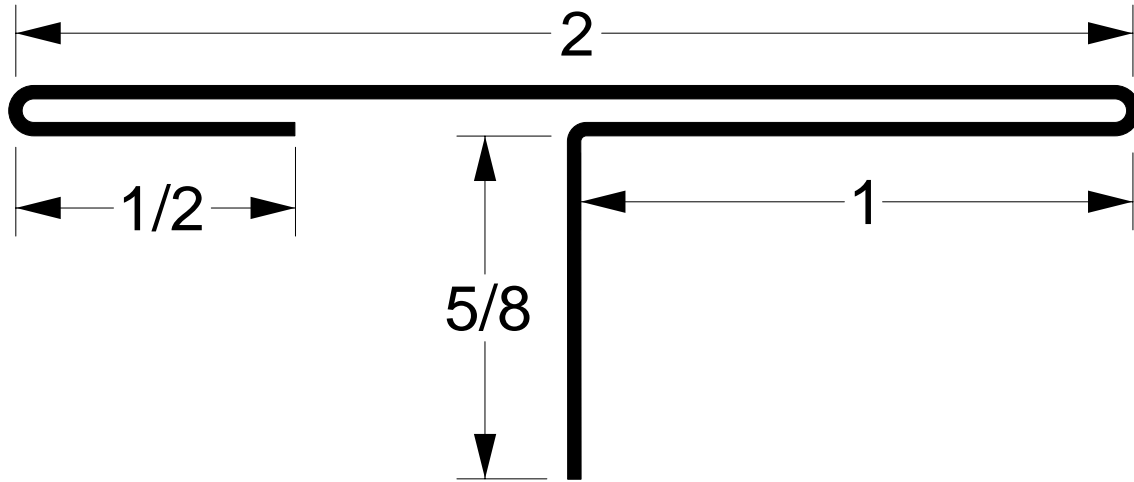

Snap-T Inside Corner #717

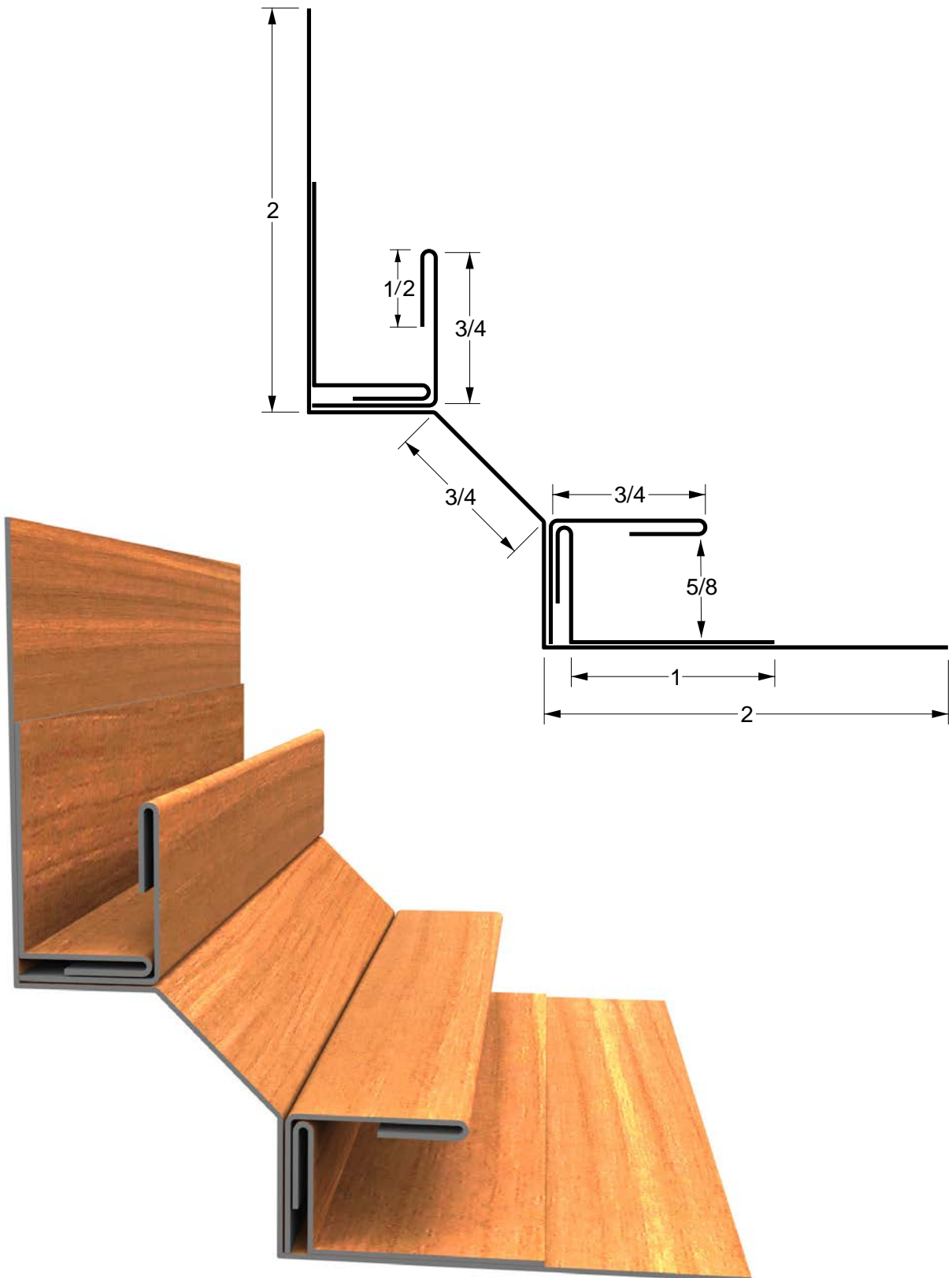

Two Piece Joiner J #718

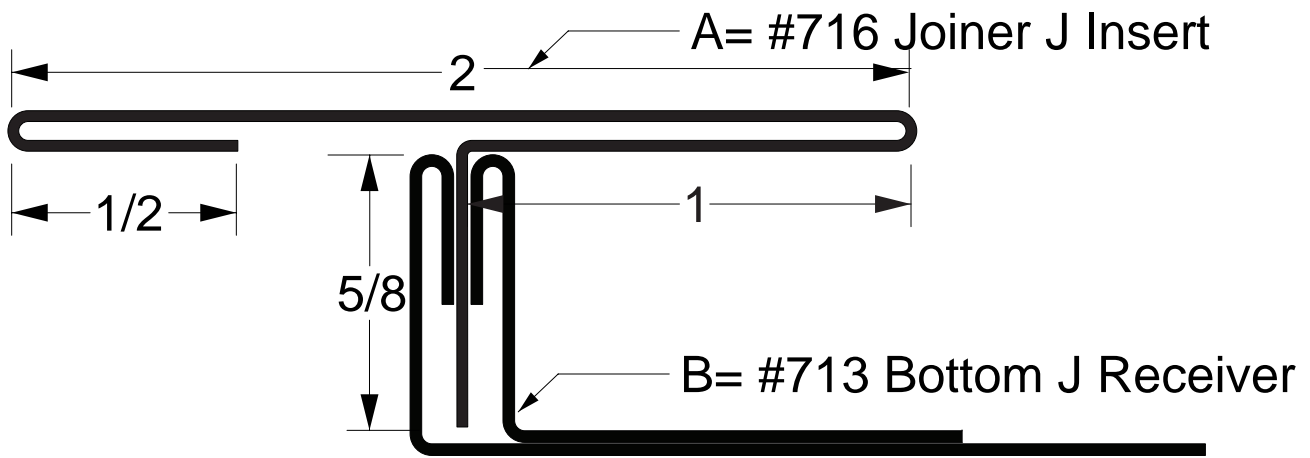

A+B = #718 Two Piece Pocket Joiner J



Snap-T Outside Corner Insert #723

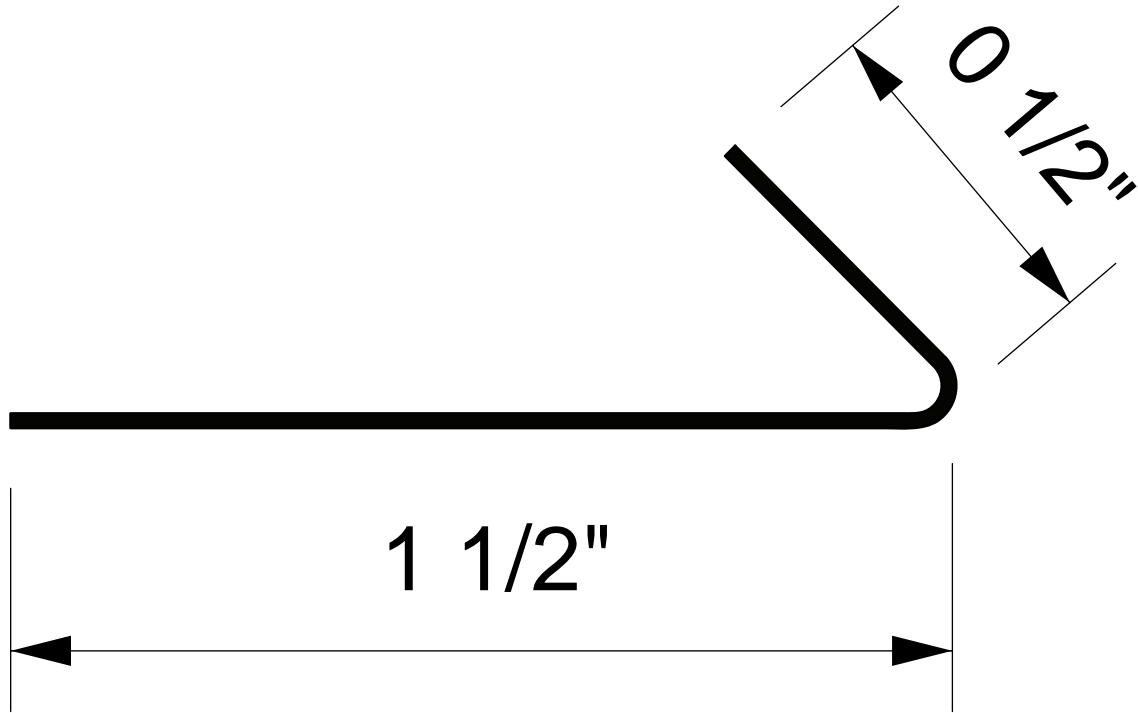

Snap-T Outside Corner Base #724

